

Selecting, Constructing, Operating and Maintaining High Performance 6 Meter Yagis

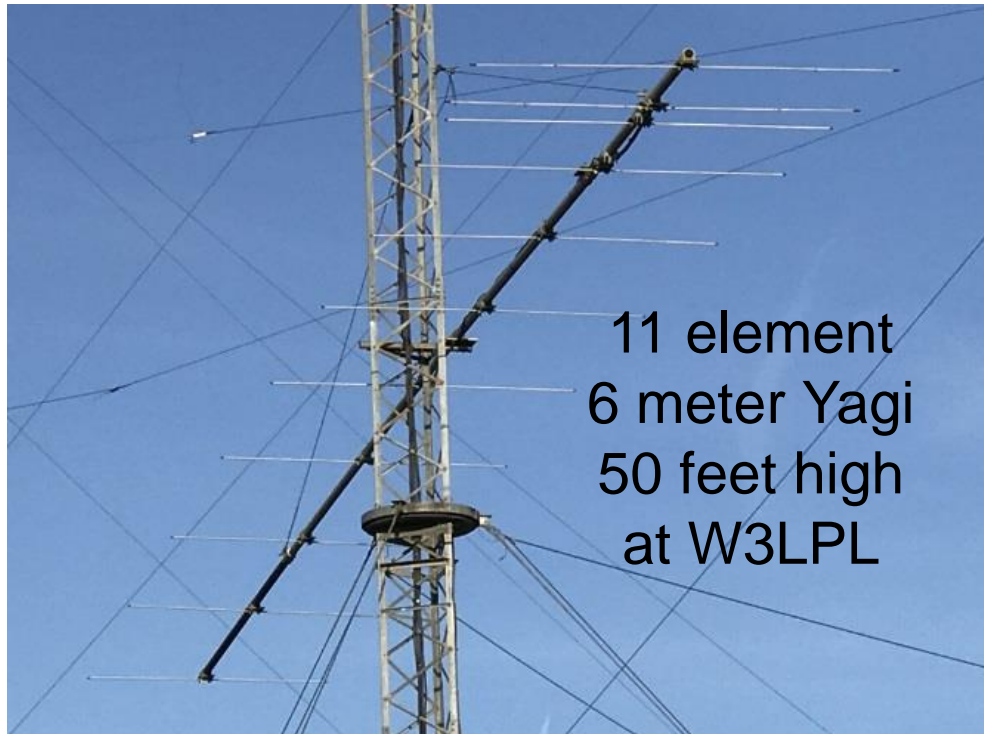
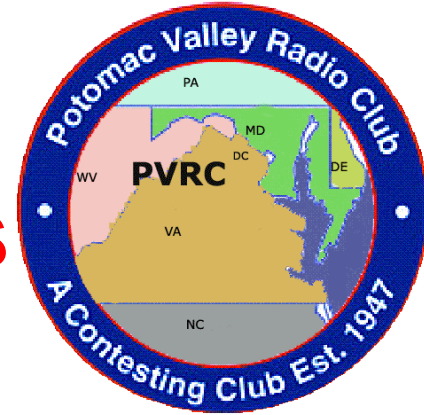

11 element
6 meter Yagi
50 feet high
at W3LPL

Frank Donovan
W3LPL
donovanf@erols.com

The Most Valuable Investment for any Antenna Builder

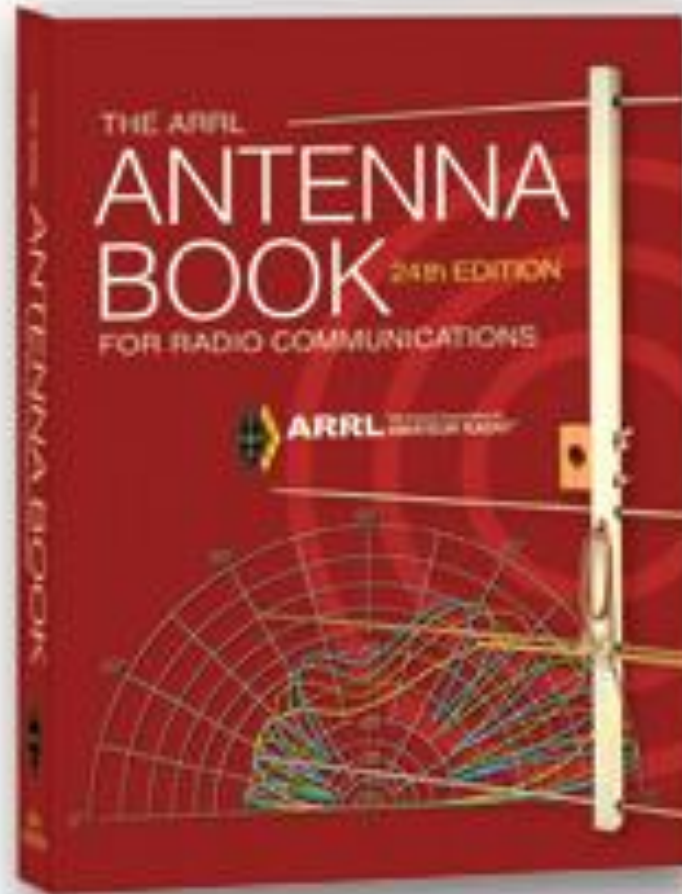
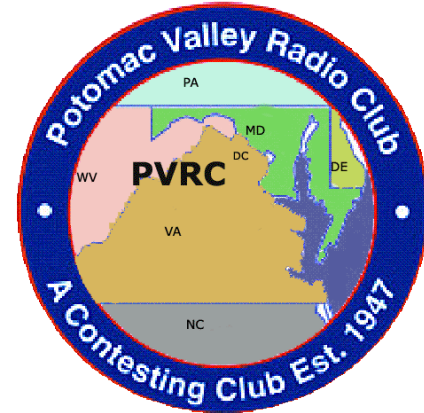

www.arrl.org/shop/ARRL-Antenna-Book-Softcover

What Causes Sporadic-E (E_s)?

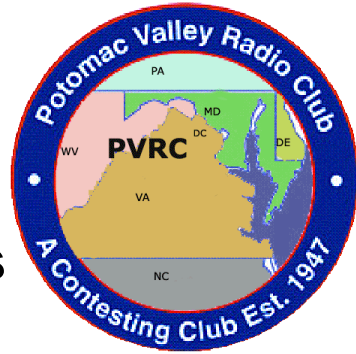

The daily influx of dust-like metallic meteoroids is ionized by high temperature ablation **not by solar radiation**. Electrons and ions are concentrated into thin dense patches by wind shears, atmospheric tides and other forces.

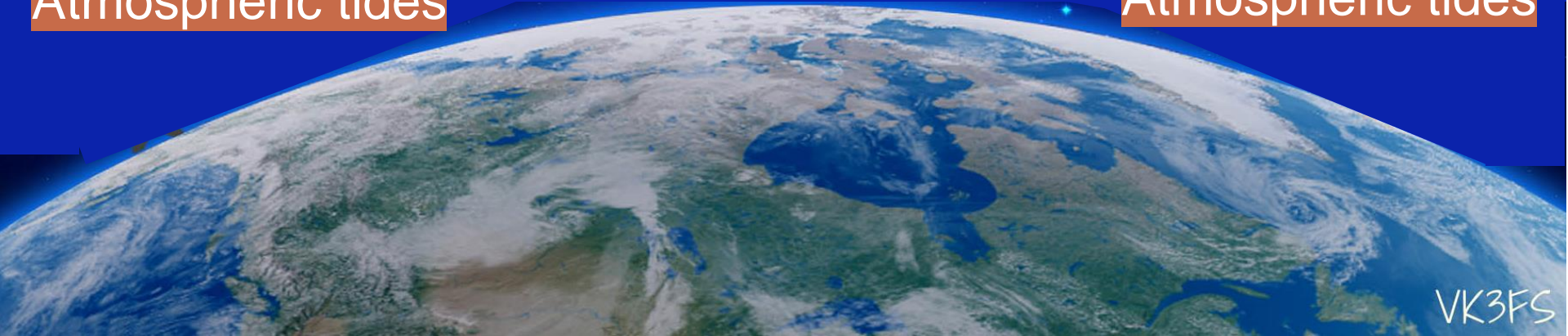
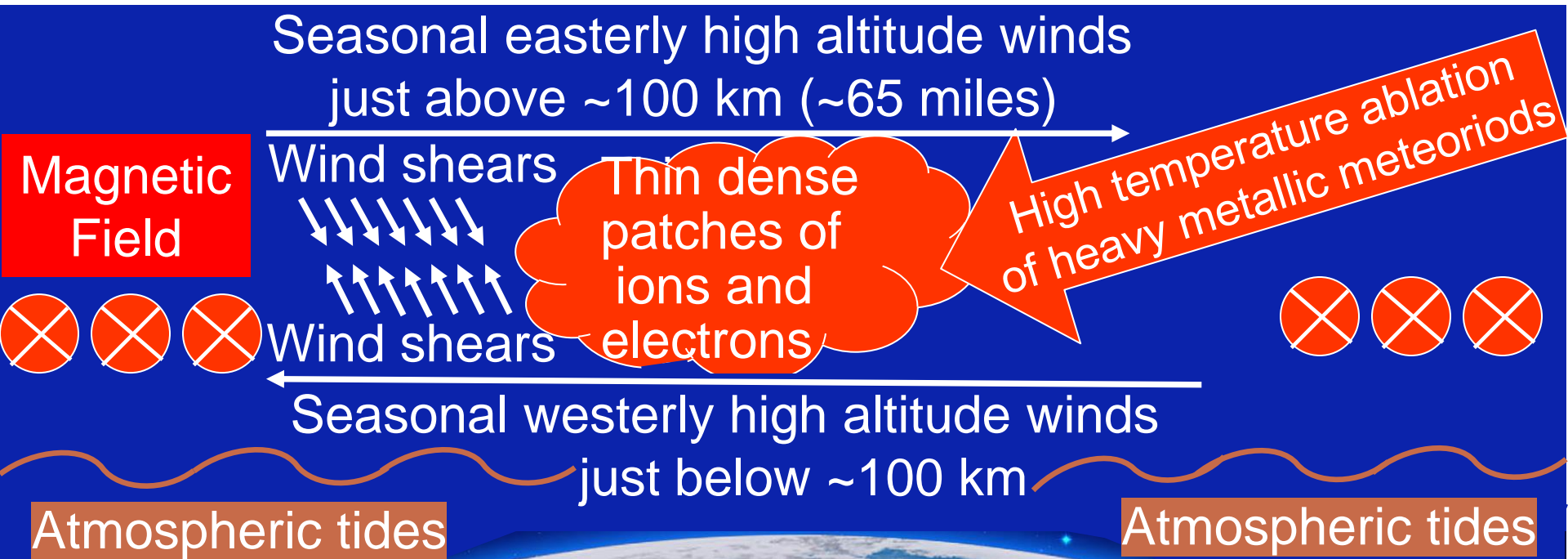

Single Hop E_s Propagation

by far the most common E_s propagation

Typically about 1400 to 2000 km (800 to 1200 miles)

Occasionally 800 to 2400 km (500 to 1500 miles)

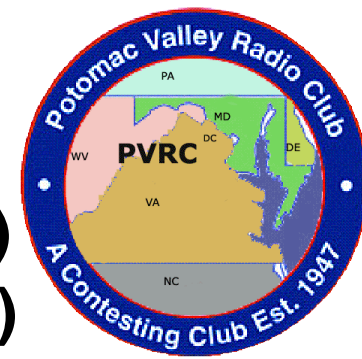

Very efficient below-the-MUF reflection
from a thin (only about 1 km thick)
dense E_s ionization patch
at about 100 km (~65 miles) altitude



Double Hop E_s Propagation

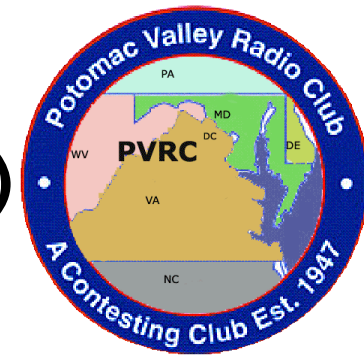

Typically about 2800 to 4000 km (1600-2400 miles)

Occasionally as little as 2000 km (1200 miles)

Very efficient below-the-MUF reflections
from two thin dense E_s ionization patches

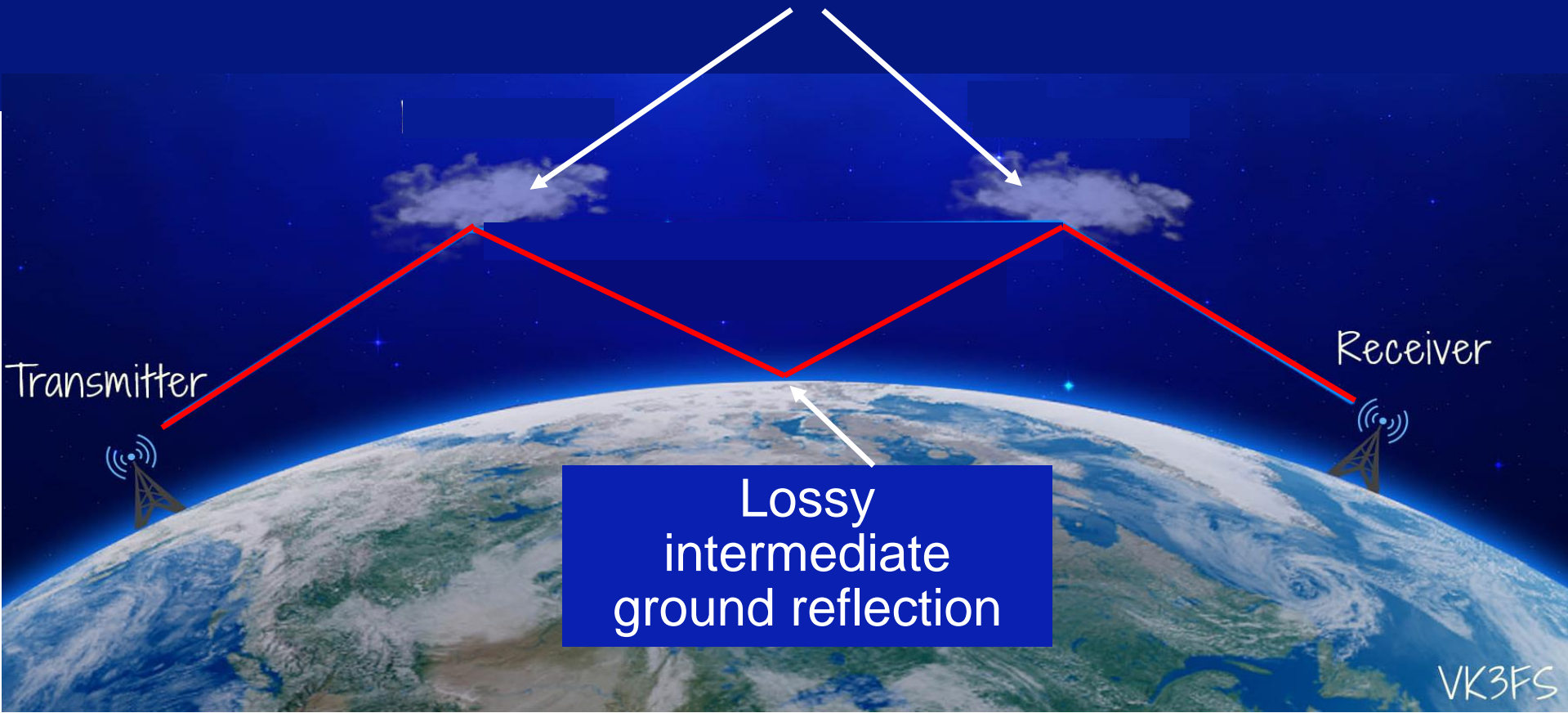

Above-the-MUF Partial Reflections via Chordal Hops between E_s Patches

2000 km (1200 miles) to 10,000+ km (6000+ miles)

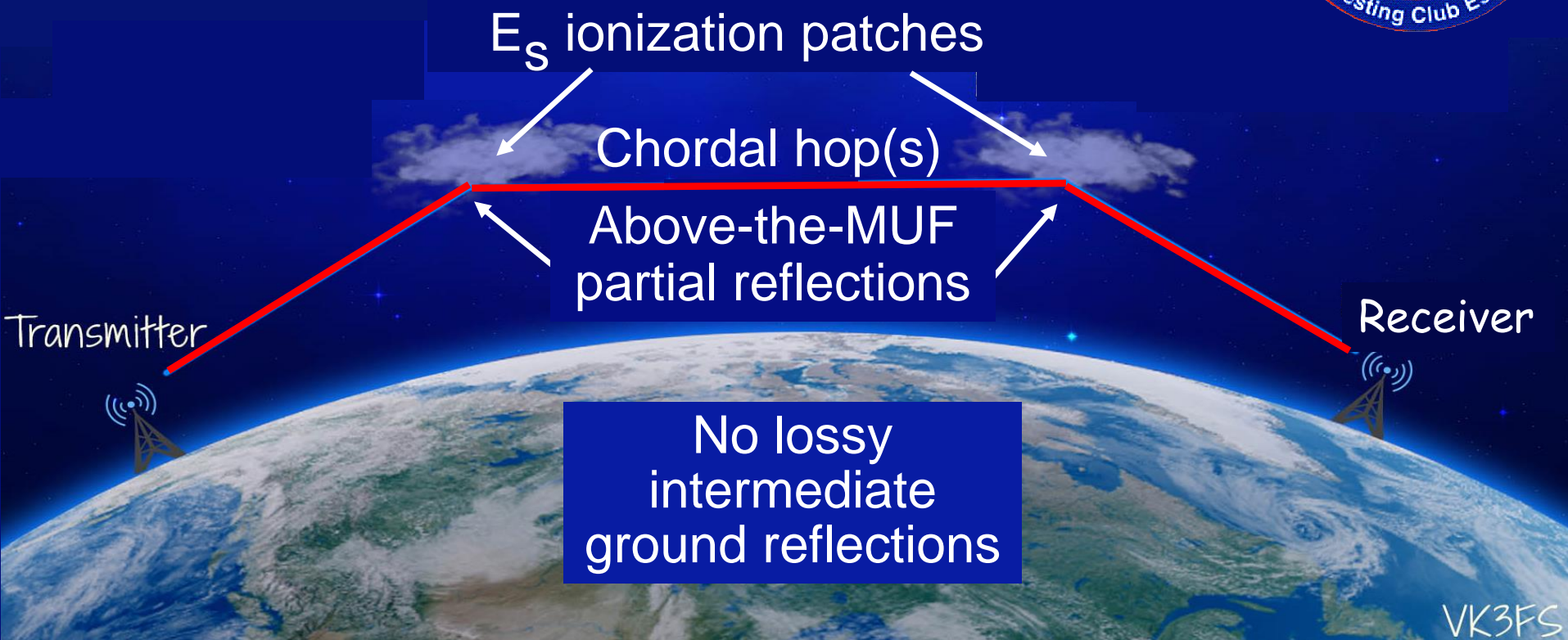
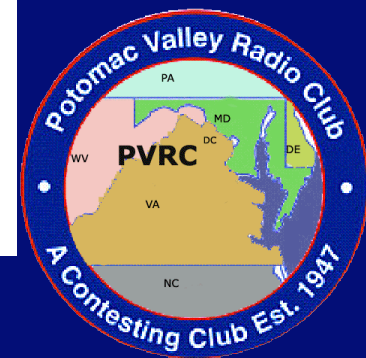

E_s ionization patches are often capable of efficient above-the-MUF partial reflection at higher frequencies than reflections returning to Earth

Partial reflections may propagate between two or more E_s ionization patches via chordal hops with no lossy intermediate ground reflection

Observed E_s Patch

June-July Occurrence Rates

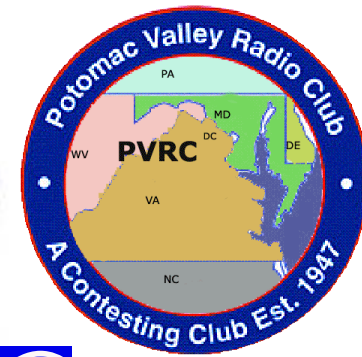

at 50-55° North Latitude

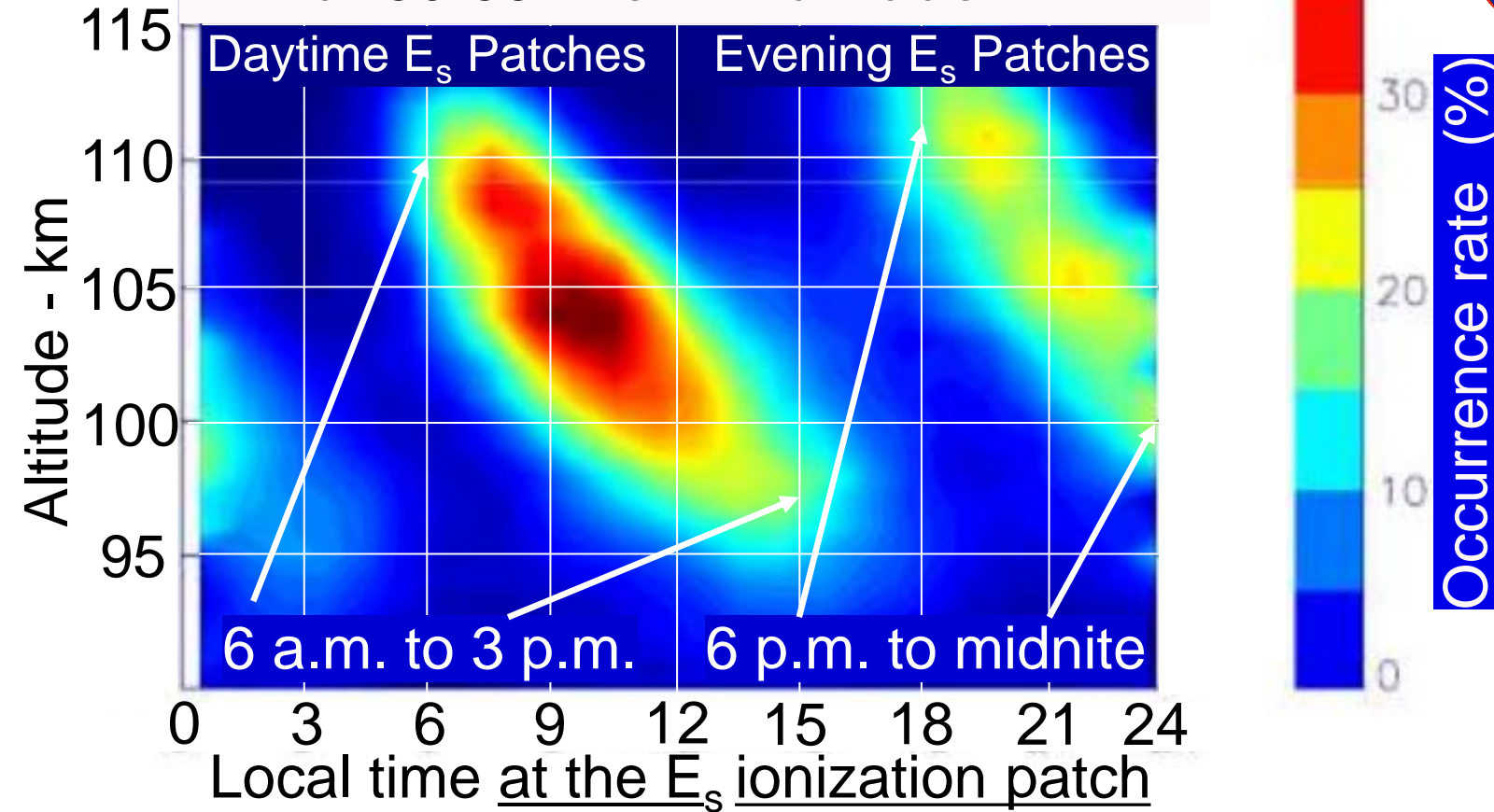

June and July high altitude wind shears cause distinct morning/afternoon and evening/night peak E_s occurrence rates

Image credit: GFZ German Research Centre for Geosciences

Increased Meteor Count at Northern Latitudes from Mid-May to Mid-August Correlates to the E_s Vertical Incidence Critical Frequency (F_oE_s)

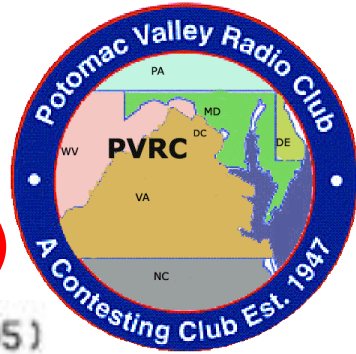

JULIUSRUH/ANDENES Meteor radars (Sep. 12, 00 - Dec 7, 05)
Athens (38 N) Digisonde (Sep 12, 00 - Dec 7, 05)

Average Daily Meteor Count

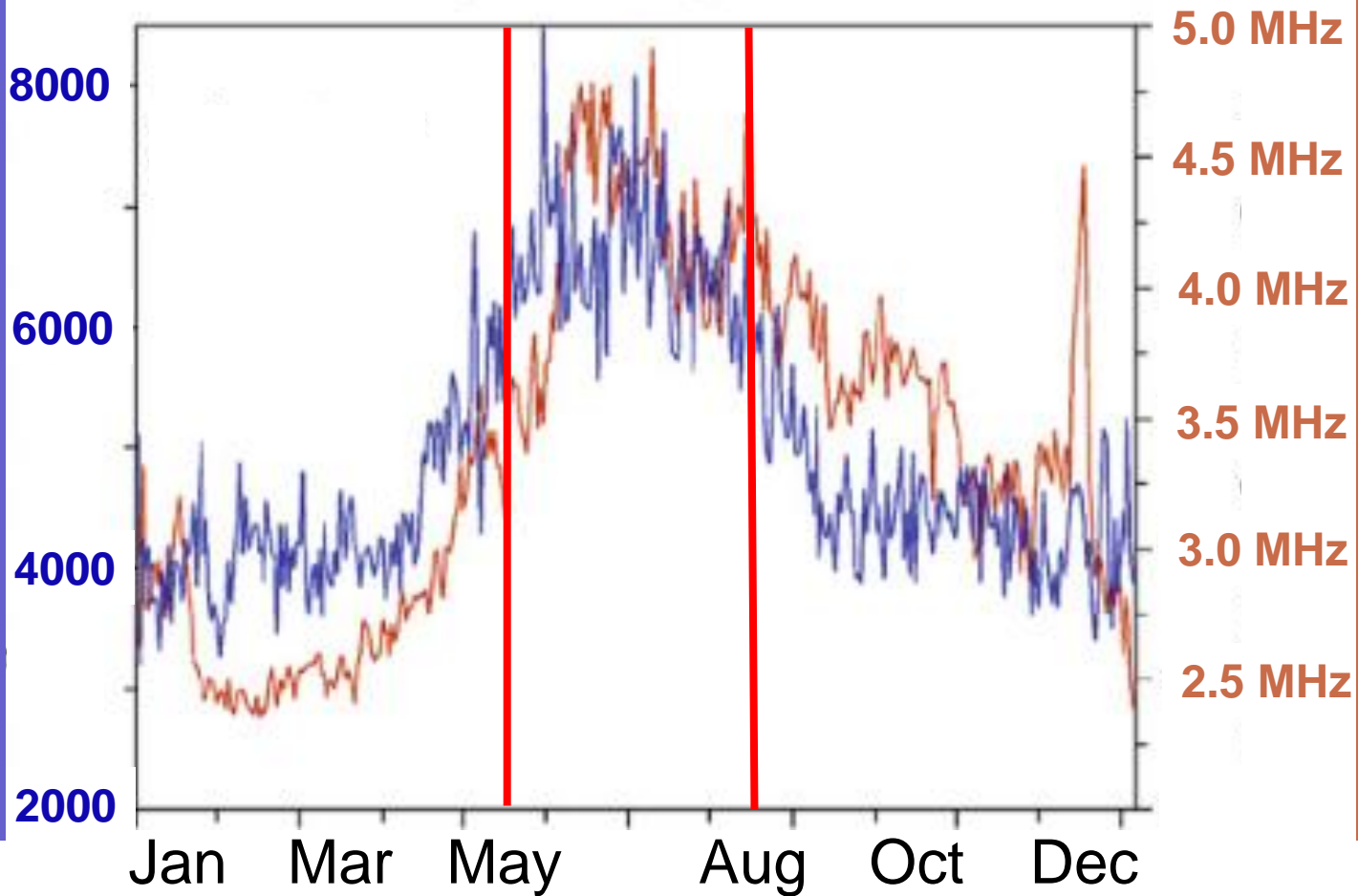

Average Daily Vertical Incidence Critical Frequency F_oE_s

Electrons and ions ablated from background meteoroids persist for many hours to a day after the 4 to 8 a.m. peak meteoroid influx

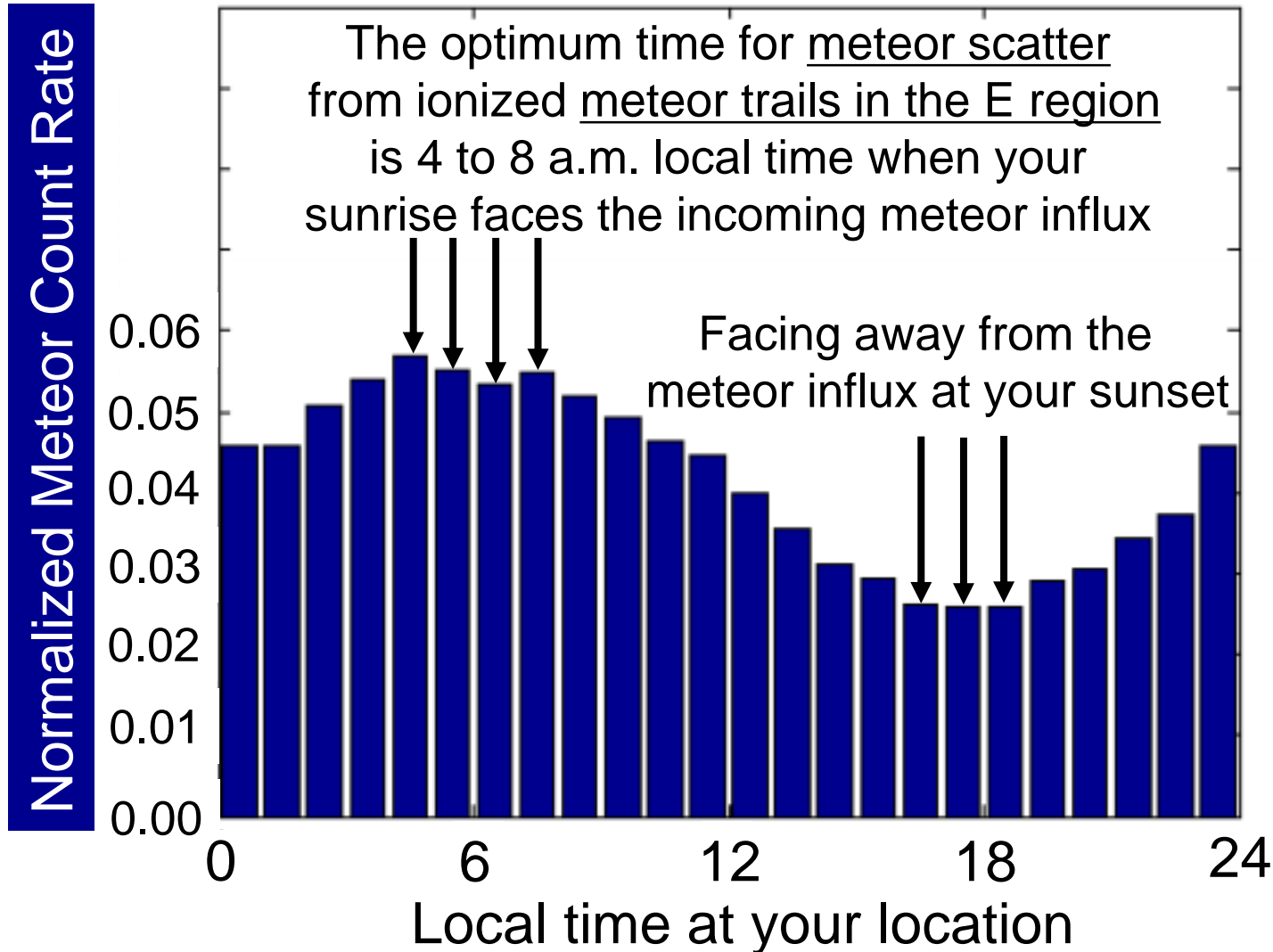
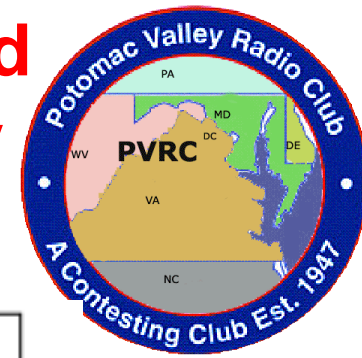

6 Meter E_s Propagation

Basic Characteristics

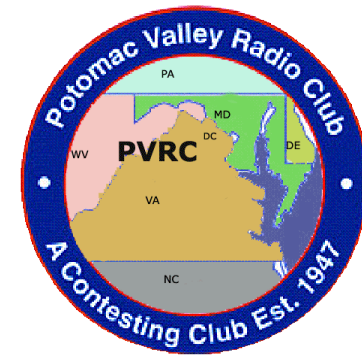

| | |
|---|---|
| Typical propagation ground footprint | Several thousand square miles to about ten thousand square miles or more |
| MUFs | >50 MHz MUFs every day in June and July -- but not everywhere <u>and</u> every day -- |
| 4000 to 10,000+ km propagation | <u>Many days</u> in June and July - a few days in late May and early August - a few days in late December/early January |
| Preferred antenna | 3 to 6 (or more) element horizontal Yagi |
| Preferred heights | 50 to 60 feet high (70 feet only for DXing) |
| Compromise height can be degraded by many small buildings and dense forests within 1000 feet | 25 feet high: about 3 dB worse at 1000 km about 6 dB worse at 2000 km compared to 50 foot height |

Easily Observed Variability

of Northern Hemisphere E_s Propagation

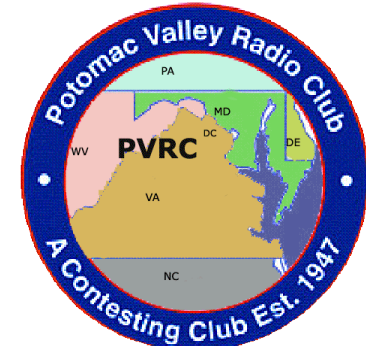

| | |
|--------------------------------------|---|
| Monthly E _s occurrence | <u>Every day</u> in June and July - but not everywhere <u>and</u> every day <u>Many</u> days in May and August <u>Some</u> days in December and January <u>Very infrequent</u> in February and March |
| Daily E _s peak occurrence | 6 am to 3 pm and 6 pm to midnight local time during June and July |
| E _s patch locations | Extreme E _s patch location variability |
| Day-to-day | Extreme E _s patch location variability |
| Day-to-night | June and July E _s propagation occurs from just before sunrise to just after midnight <u>at the location of the E_s ionization patch</u> |
| Short term | Seconds, minutes, hours, morning-to-evening |

Antenna Heights and Elevation Angles for 6 Meter E_s Propagation

(thanks K9LA)

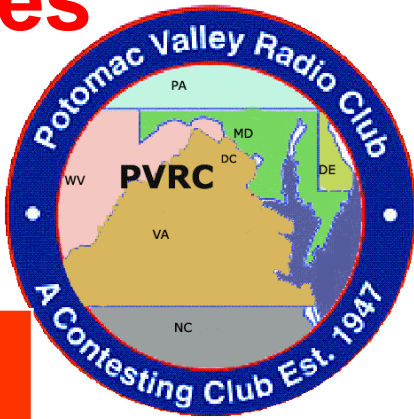

| Antenna Elevation Angles | Single Hop E _s Distance | Required F _o E _s (MHz) | Approx E _s MUF (MHz) | Optimum Antenna Height | Occurrence |
|--------------------------|------------------------------------|--|---------------------------------|------------------------|---------------|
| Below 5° | 1400-2300 km | 9-10 | 45 | 70 feet | Frequent |
| 5° to 8° | 1200-1400 km | 10-11 | 50-55 | 50 feet | Very Frequent |
| 8° to 12° | 800-1200 km | 11-13 | 55-65 | 25 feet | Not Frequent |
| 12° to 15° | 700-800 km | 13-15 | 65-75 | 17 feet | Rare |

E_s vertical incidence critical frequency (F_oE_s) does not often exceed 12 MHz

Multi and chordal hop E_s occurs very frequently below about 5° elevation angles

Yagis more than about 100 feet high are much too high for most E_s propagation

Few QSO partners have useful antenna response below about 3° elevation

The Reference Antenna for Yagi Antenna Gain (dBd) in this Presentation is the

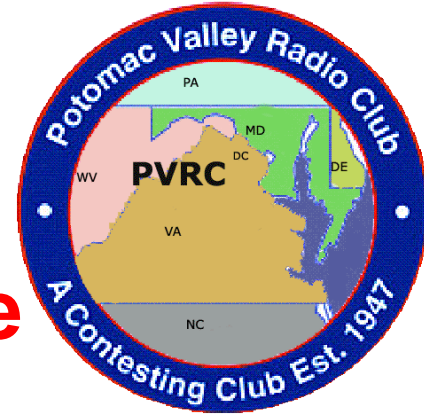

Half Wavelength Dipole in Free Space

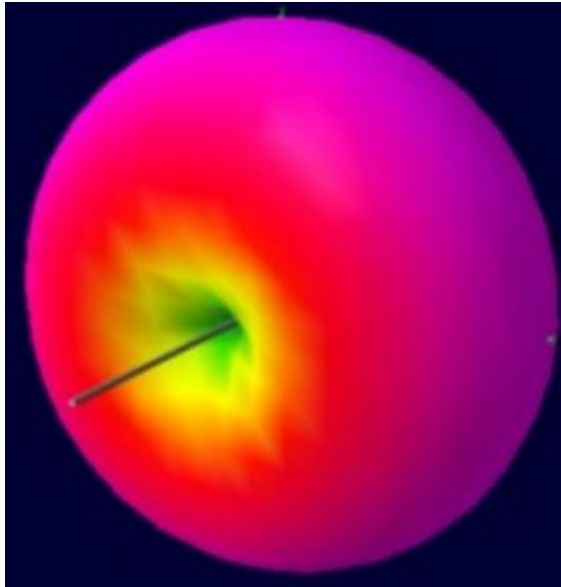

Half Wavelength Dipole
in free space

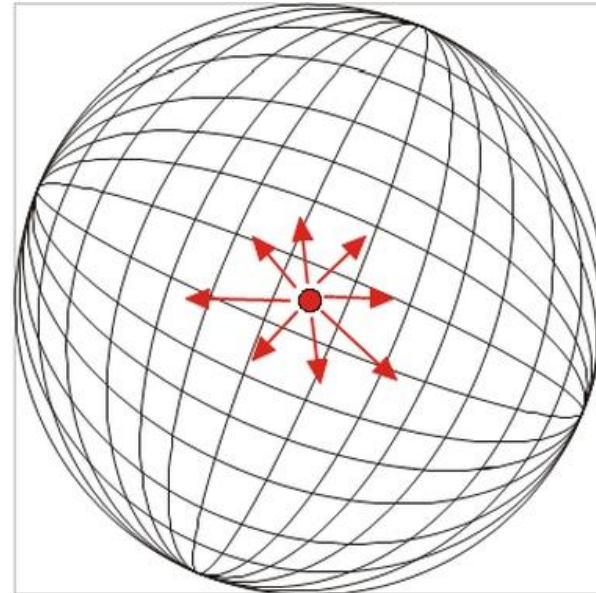

Theoretical Isotropic Radiator

A half wavelength dipole in free space has 2.15 dB gain over an isotropic radiator

Elevation Pattern

5 element 6 meter Yagi 50 feet high

Excellent height for almost all E_s

Degraded by dense housing within 2000 ft

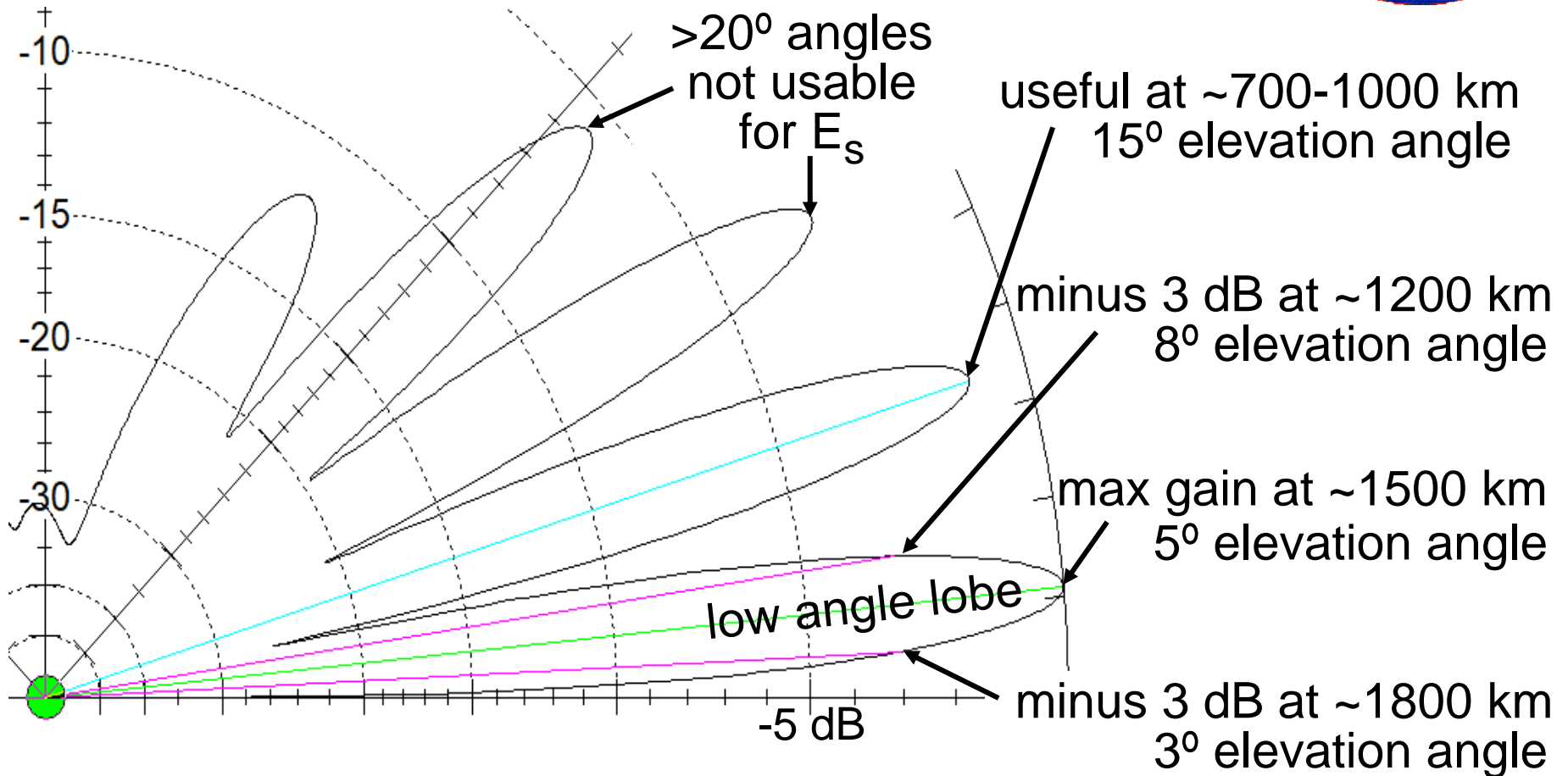
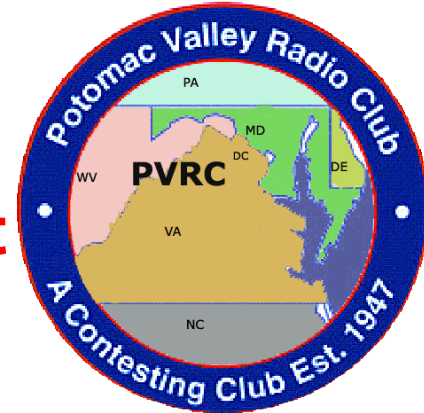

Elevation Pattern

5 element 6 meter Yagi 70 feet high
1 to 2 dB better for E_s DX than 50 feet high

Minor degradation by dense housing
Unwanted deep null at 6° to 10° elevation

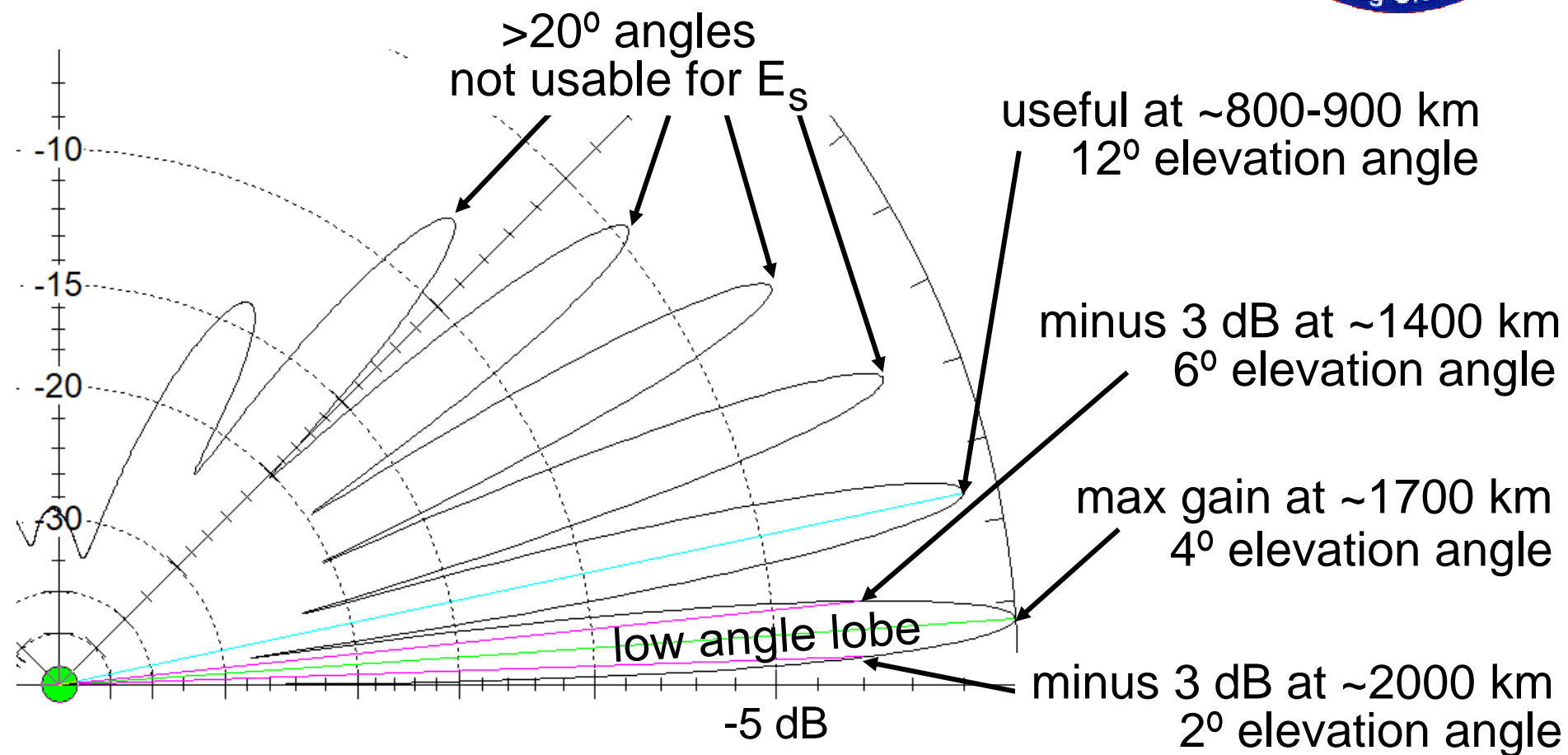
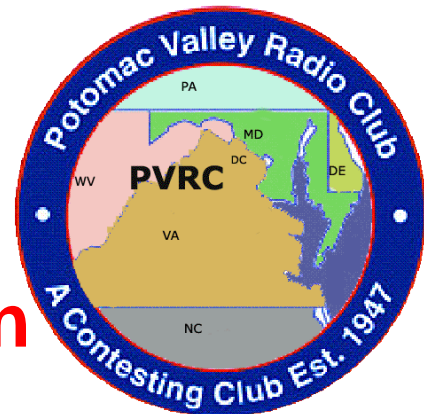

Elevation Pattern

5 element 6 meter Yagi 25 feet high

Adequate height if can't be higher

Only 3 to 6 dB worse than 50 foot height

Degraded by dense housing within 1000 feet

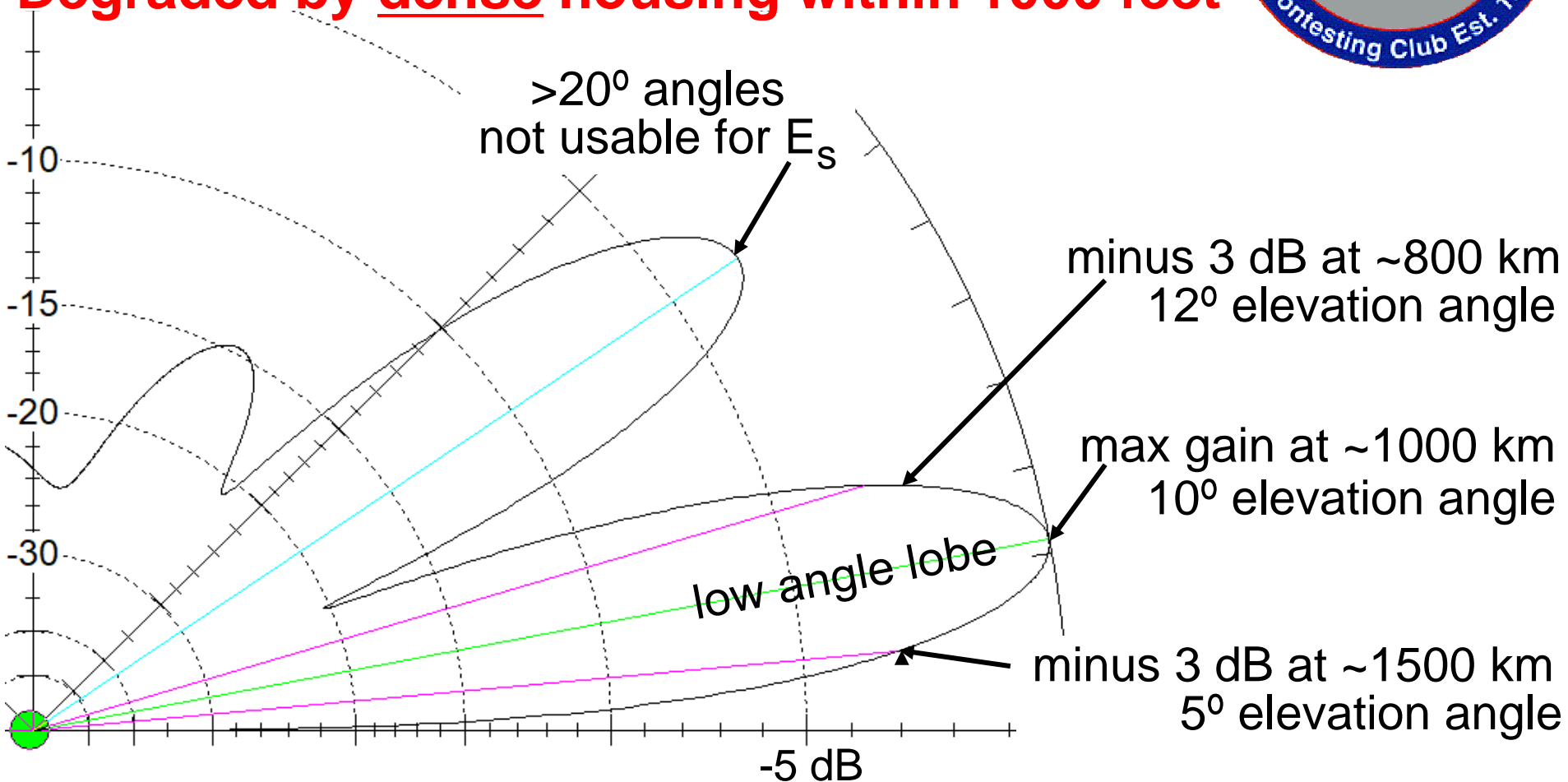
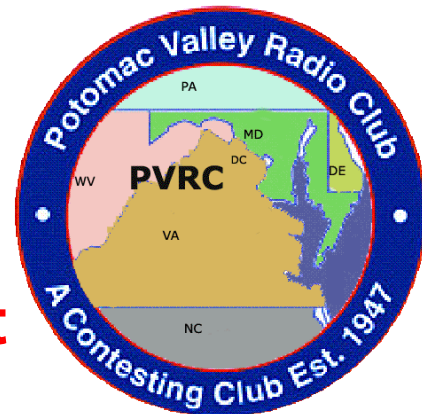

Elevation Pattern

5 element 6 meter Yagi 100 feet high

Too high for most E_s propagation

Unwanted deep null at 4° to 7° elevation

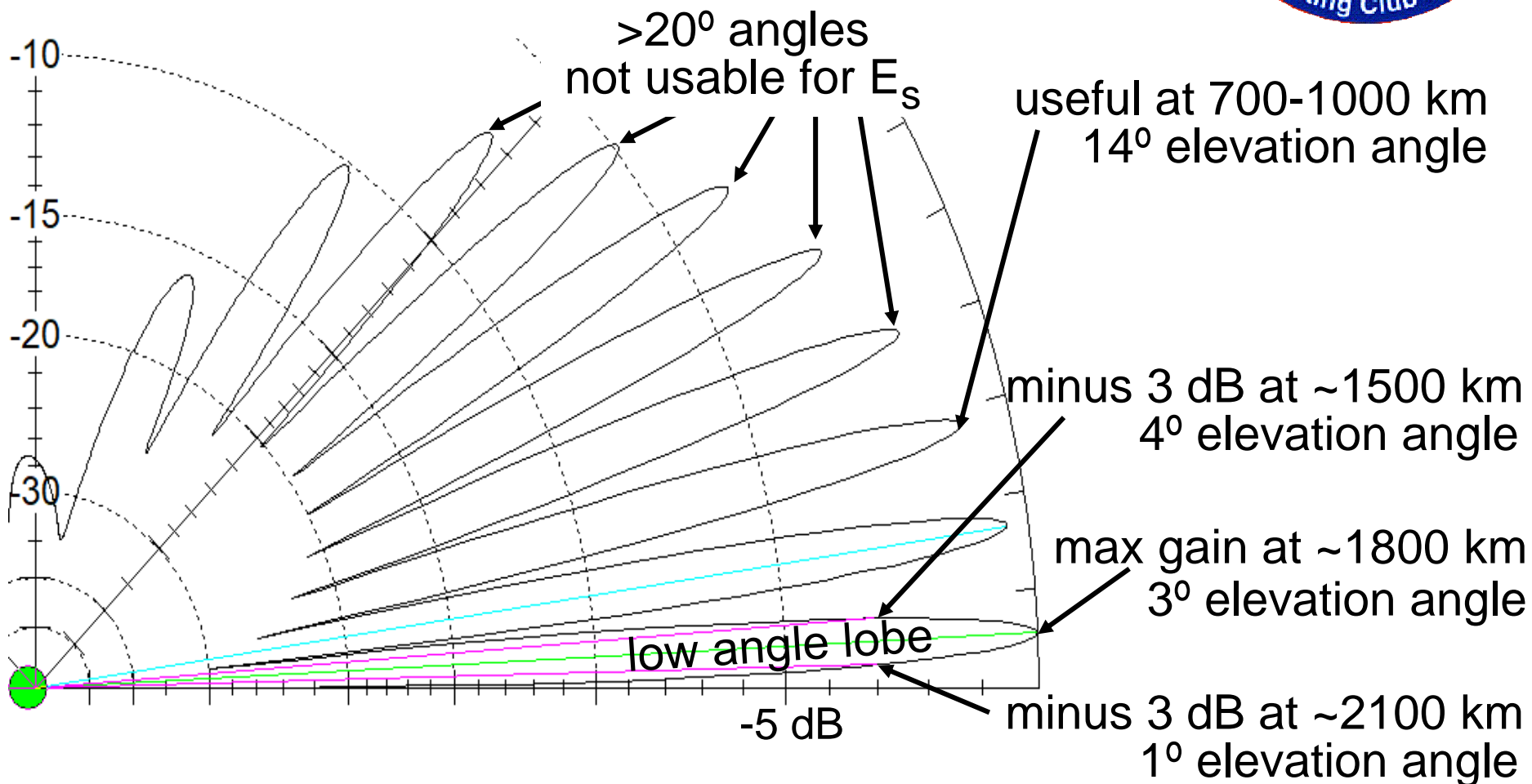
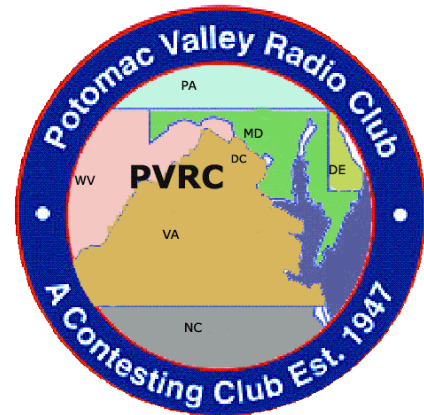

Front to Rear (F/R) Ratio

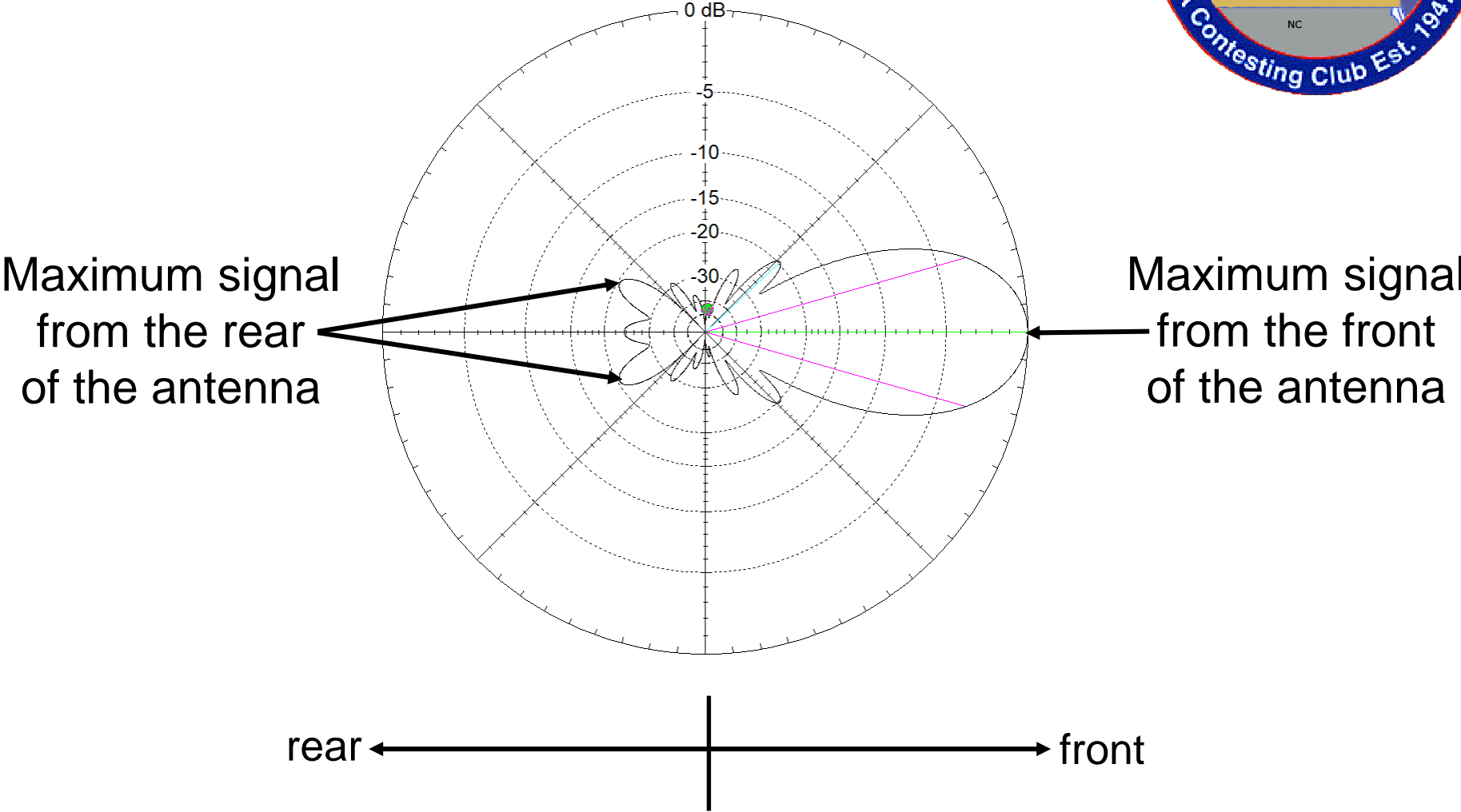
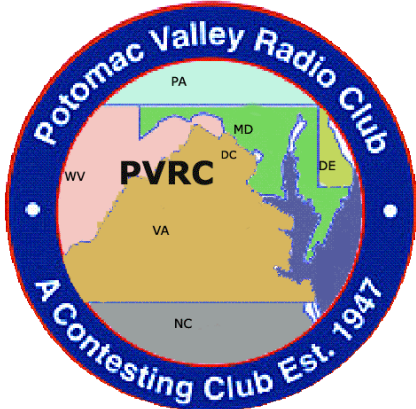

6 dBd Ground Gain of a Horizontal 1/2 Wave Dipole with Minor Irregularities in the Reflection Zone

Terrain irregularities: <25% of antenna height

Buildings: <25% of antenna height

Forest: <25% of antenna height

Obstructing less than 5% of the reflection zone

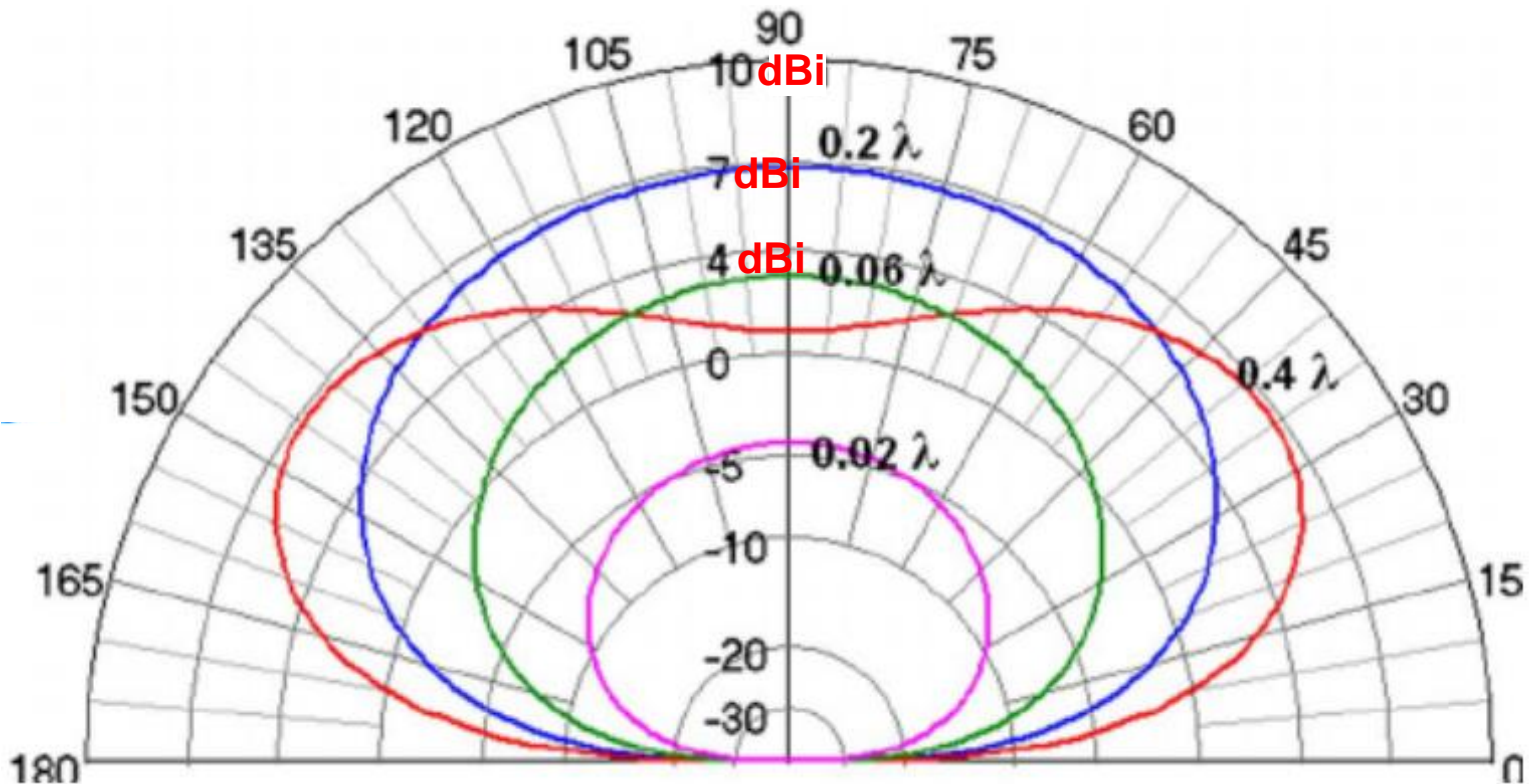
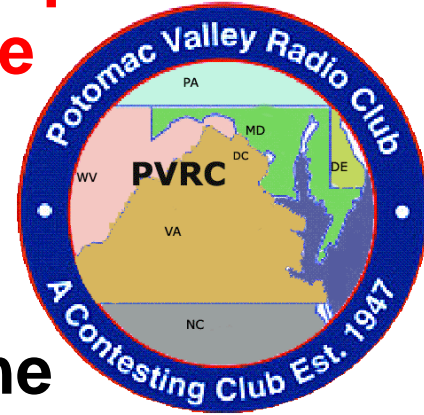

A horizontal half wave dipole at least 0.5 wavelength high with relatively smooth terrain and few tall buildings in the reflection zone has 6 dBd gain over a horizontal dipole in free space

The Classic “Image Antenna” Model

an accurate model
for computing peaks and nulls
in antenna elevation patterns

Assumes an ideal ground reflection
with no obstructions or irregular terrain

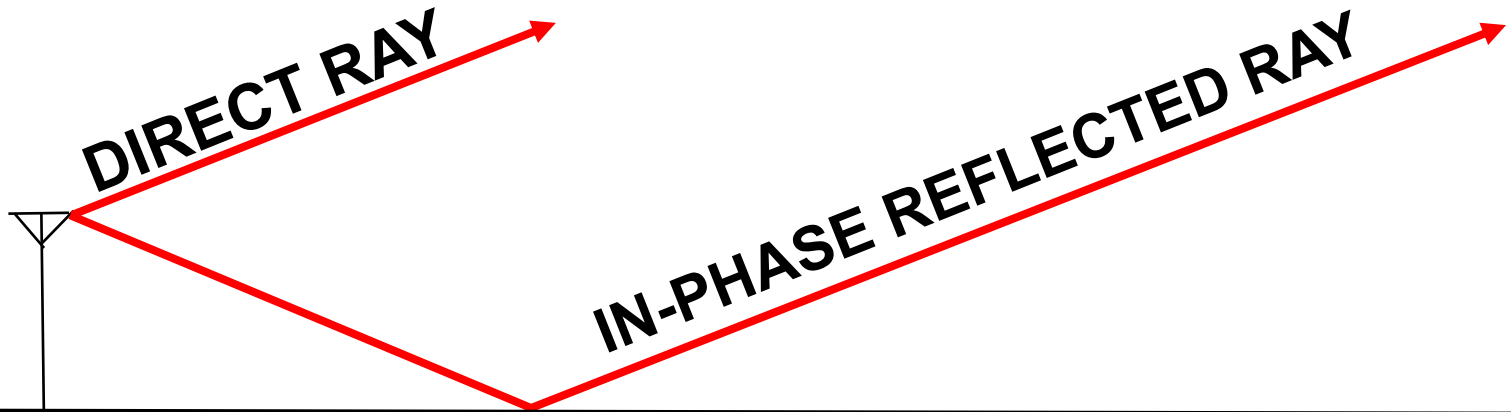
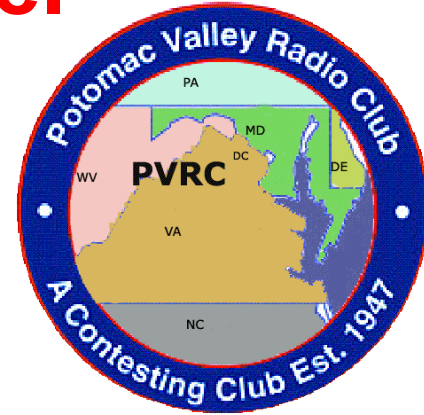

GROUND REFLECTION
WITH NO OBSTRUCTIONS
AND NO IRREGULAR TERRAIN

IMAGINARY
IMAGE
ANTENNA

What is the Actual Reflecting Zone in front of my antenna?

It definitely is not just a single point

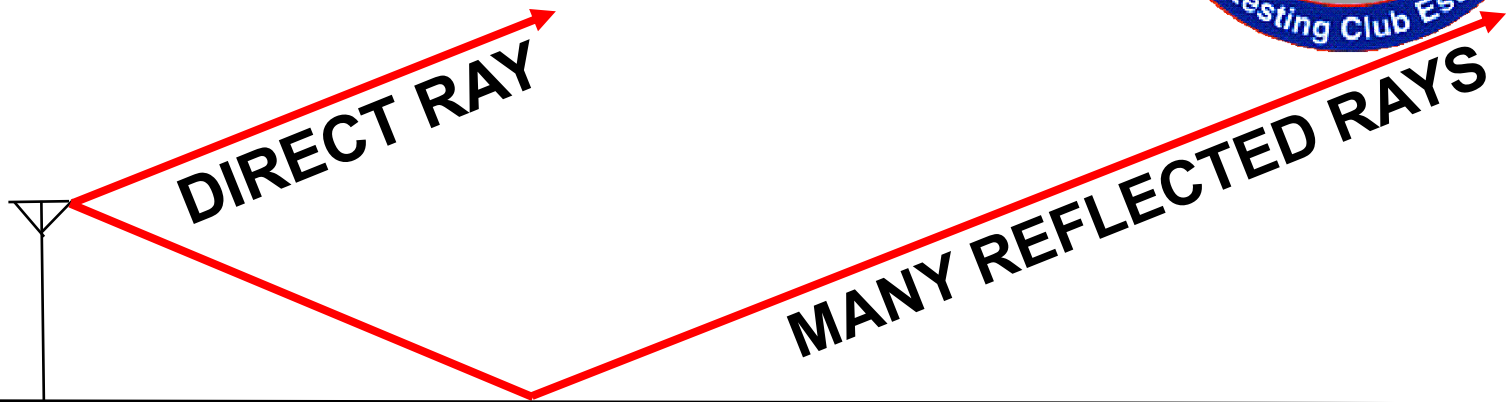
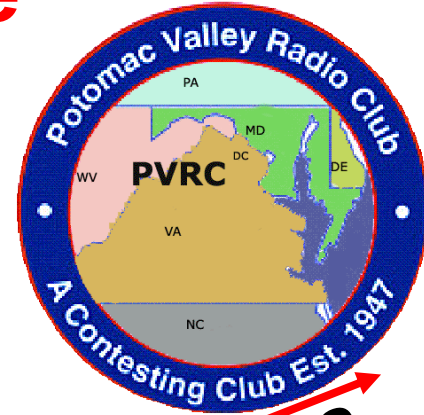

How large is it?

What is its shape?

How far in front of my antenna is it?

How much do obstructions degrade the reflection?

How much does irregular terrain degrade the reflection?

The Fresnel Zone

By definition includes all ground reflections within $\pm 90^\circ$ of the phase of the direct ray that add to the power from the direct ray if ground reflections are not obstructed or absorbed

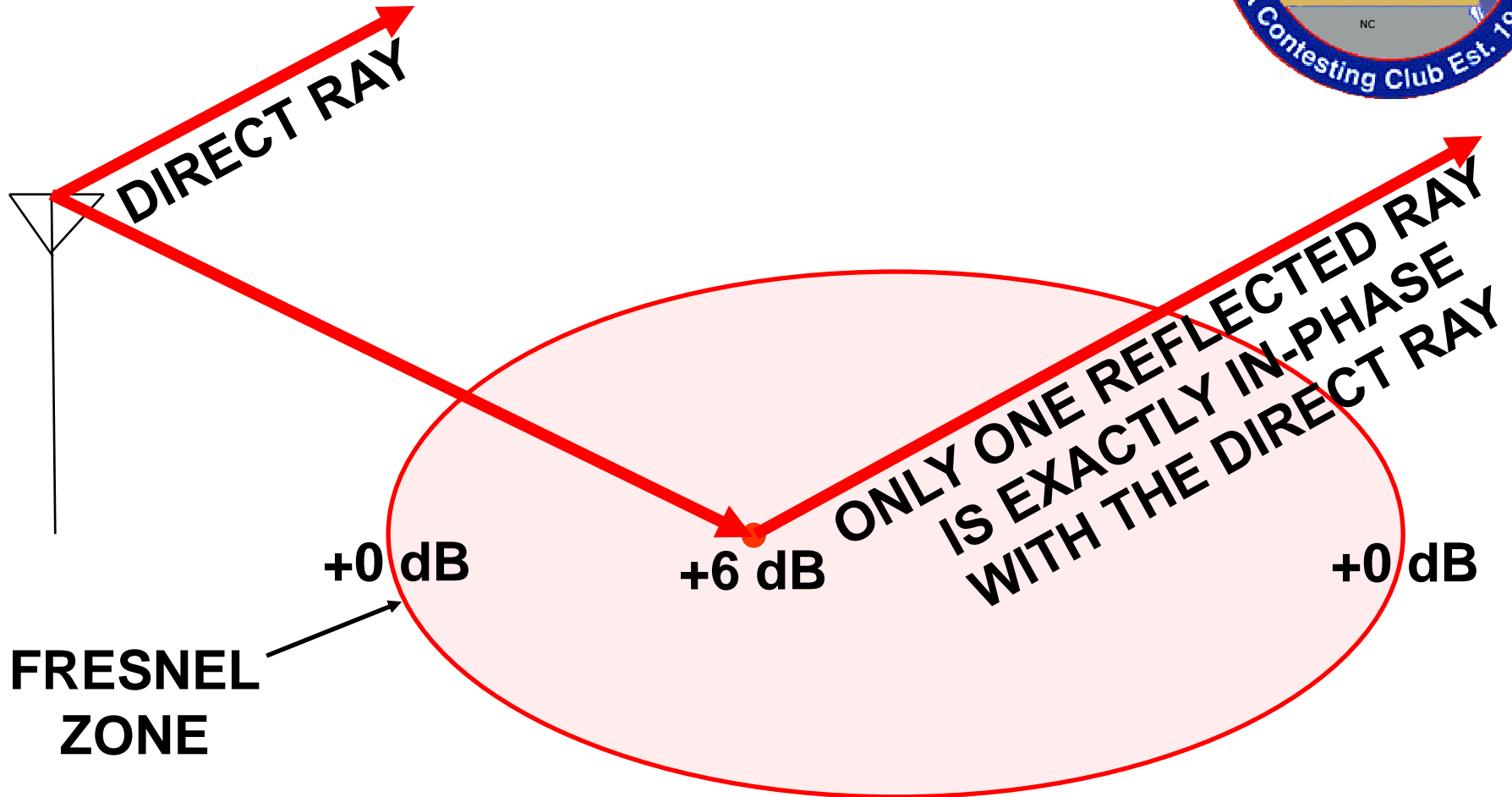
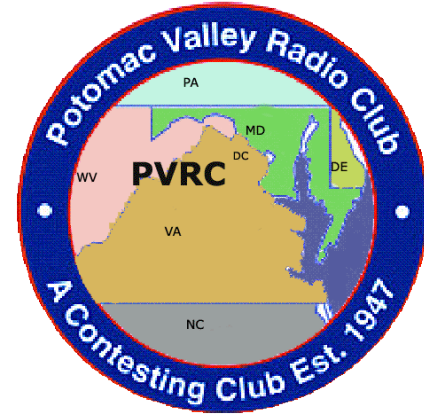

The Fresnel Zone

Unobstructed reflections closer to the center of the Fresnel zone contribute 6 dB more power to the low angle lobe than phase shifted reflections closer to the edge of the Fresnel zone

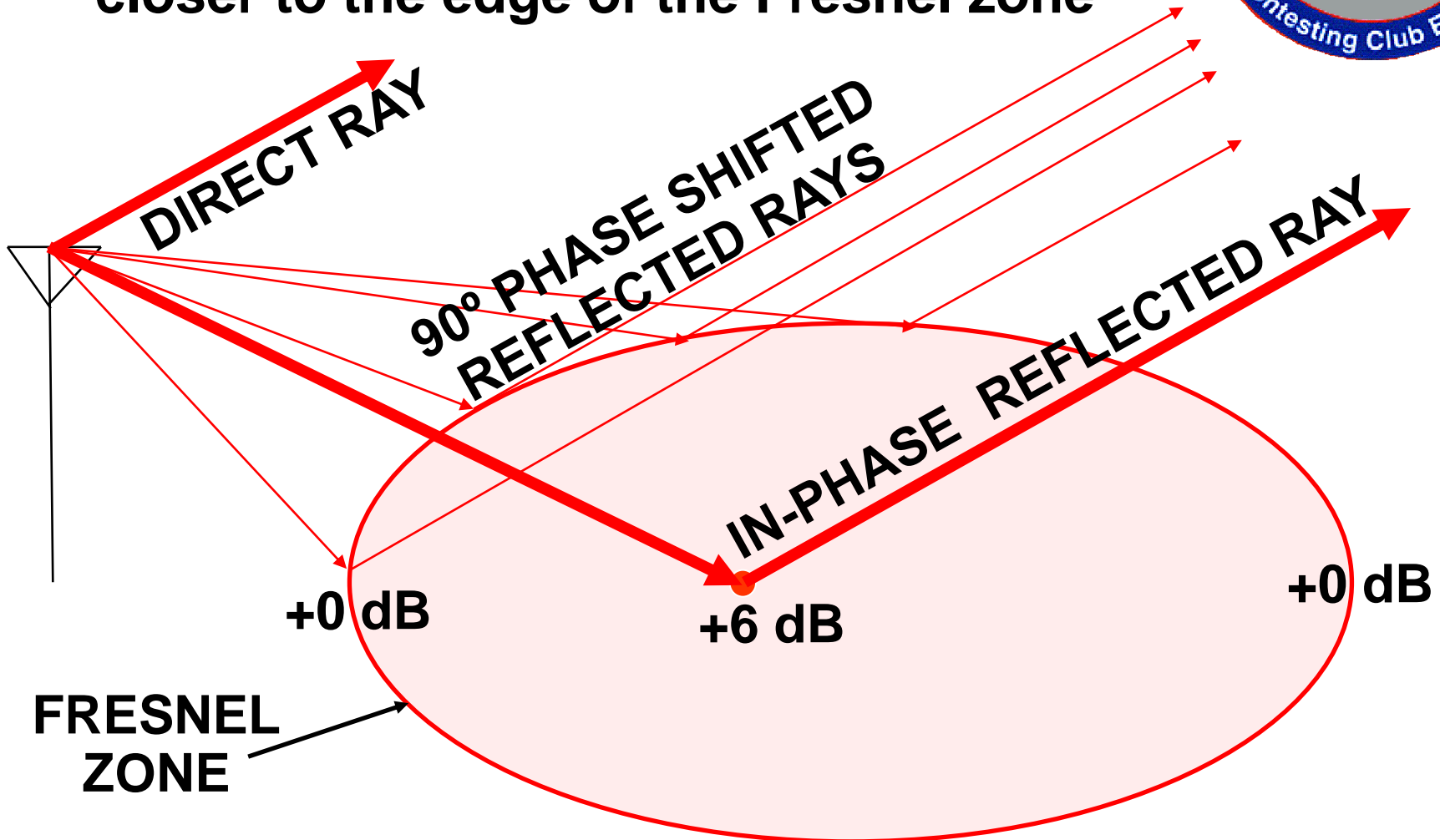
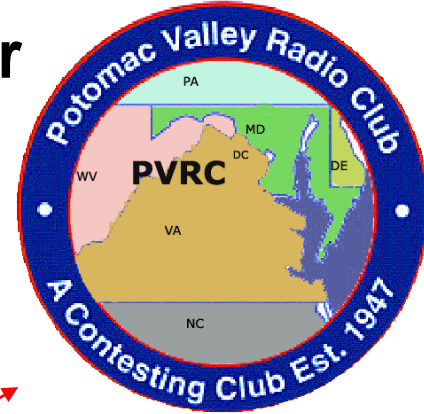

+3 dB Ground Reflection Zone

Roughly the middle half of the Fresnel zone

Ideally the reflection zone should not be obstructed

- buildings and forests occupy < 5% of the zone
- buildings and forests < 25% of antenna height
- irregular terrain < 25% of antenna height

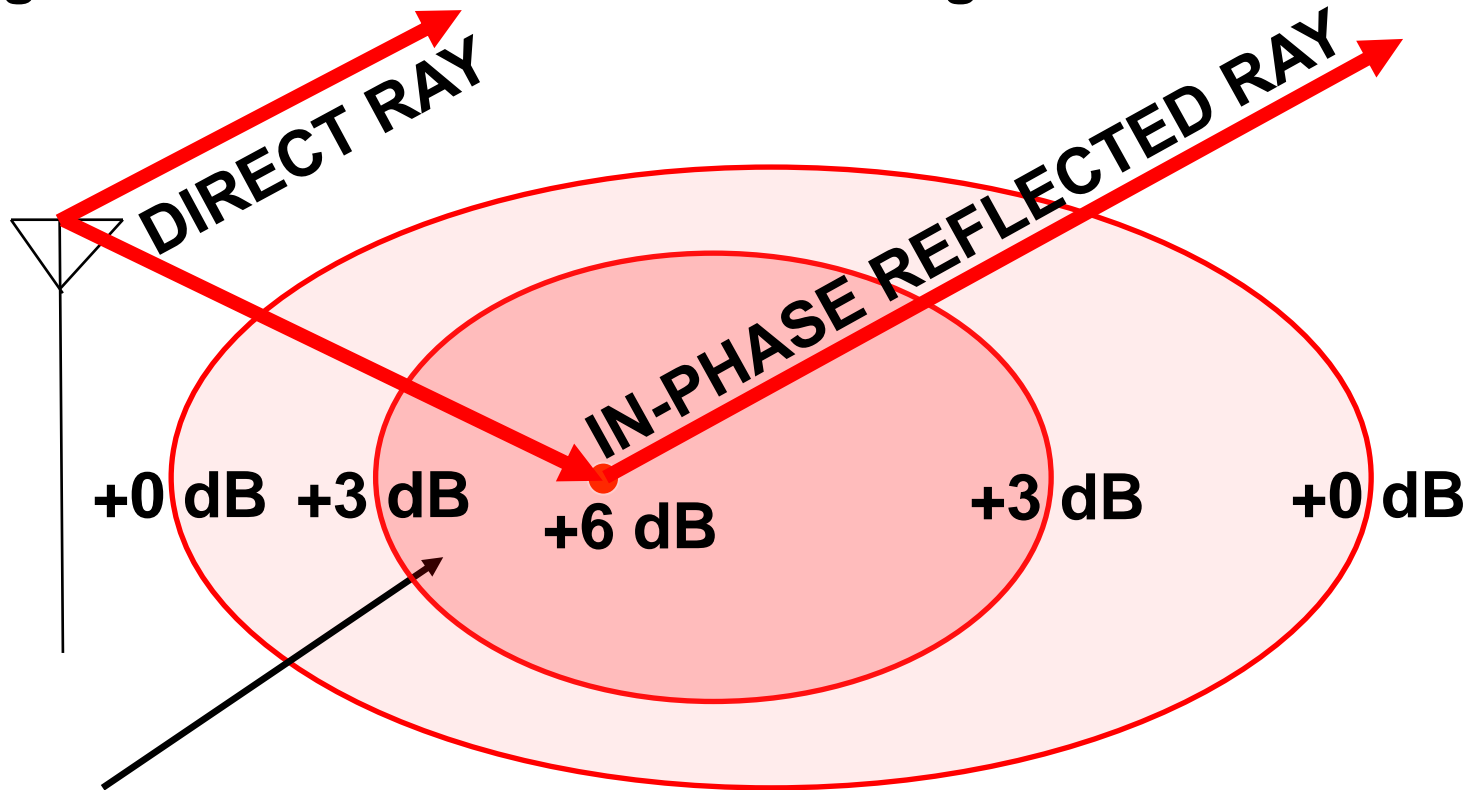
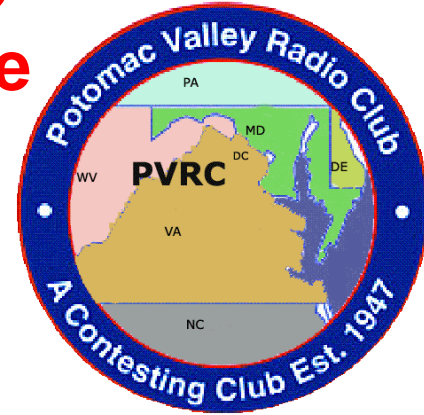

Roughly the middle half of the Fresnel zone forms most of the -3 dB contour of the antenna's low angle lobe

+3 dB Ground Reflection Zone

6 meter Yagi **50 feet** high

5° elevation angle

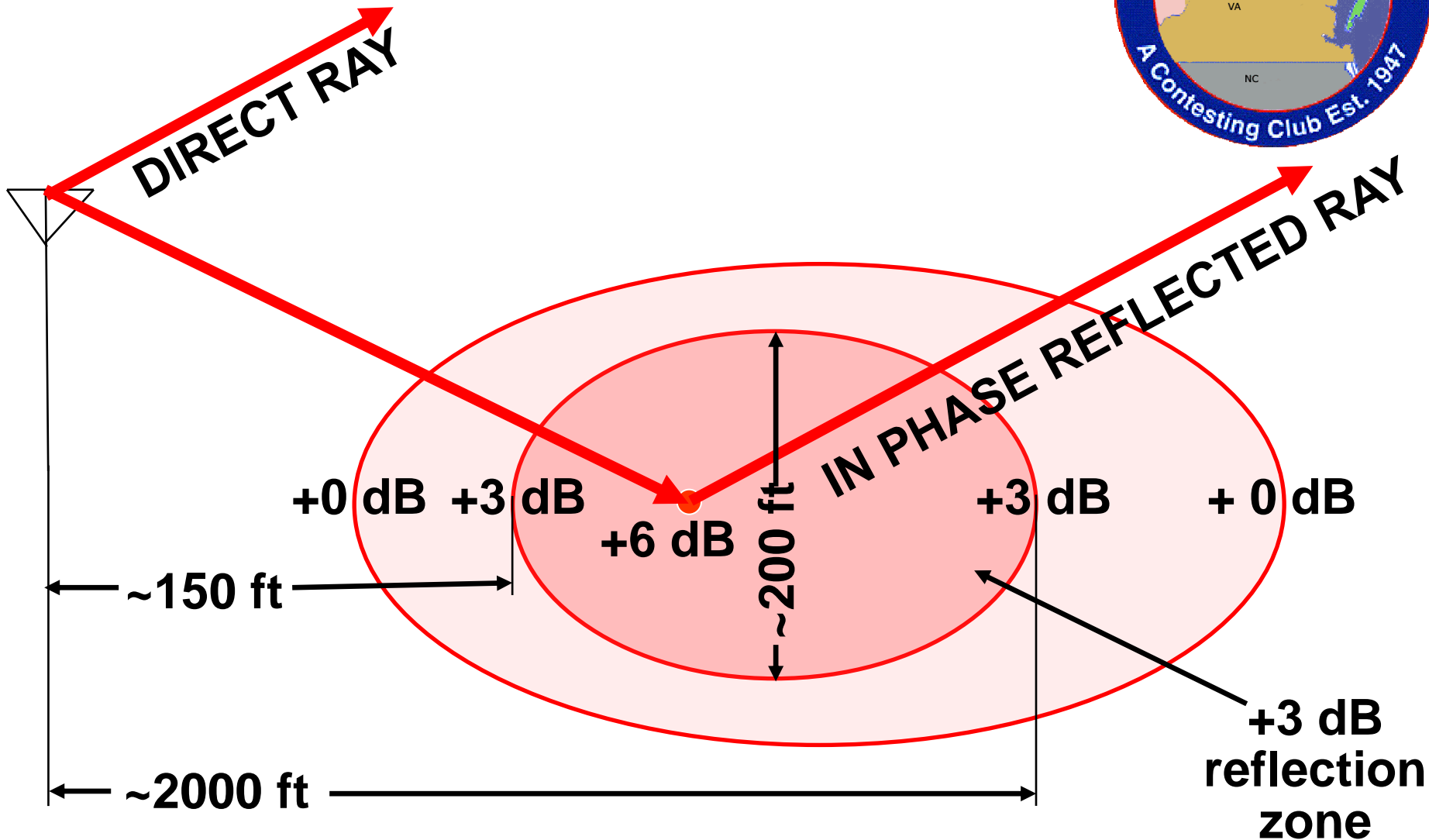
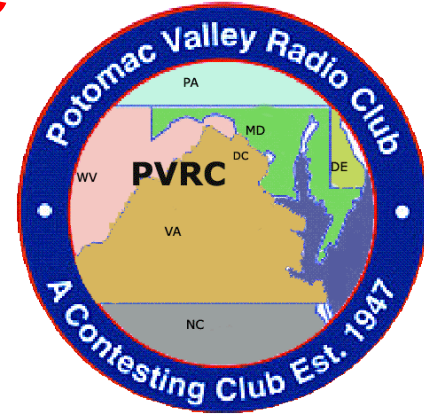

+3 dB Ground Reflection Zone

6 meter Yagi **70 feet** high

4° elevation angle

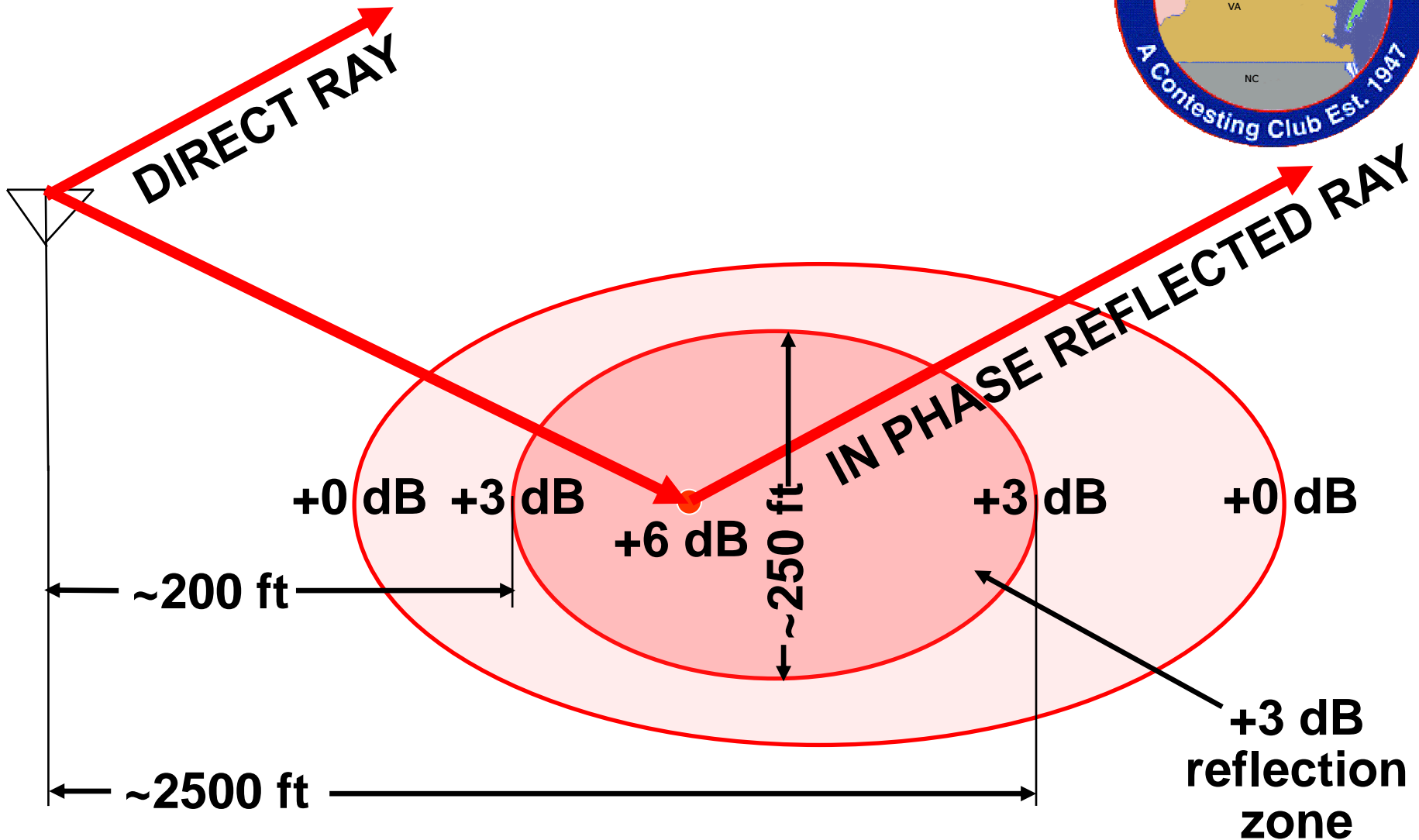
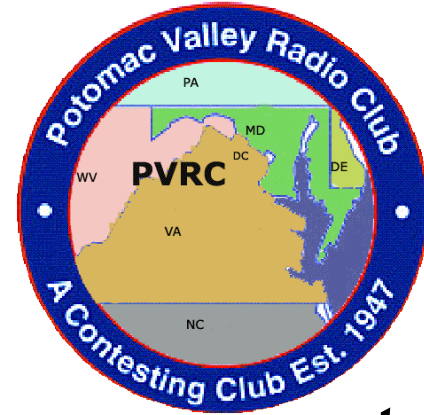

+3 dB Ground Reflection Zone

6 meter Yagi only **25 feet** high

10° elevation angle

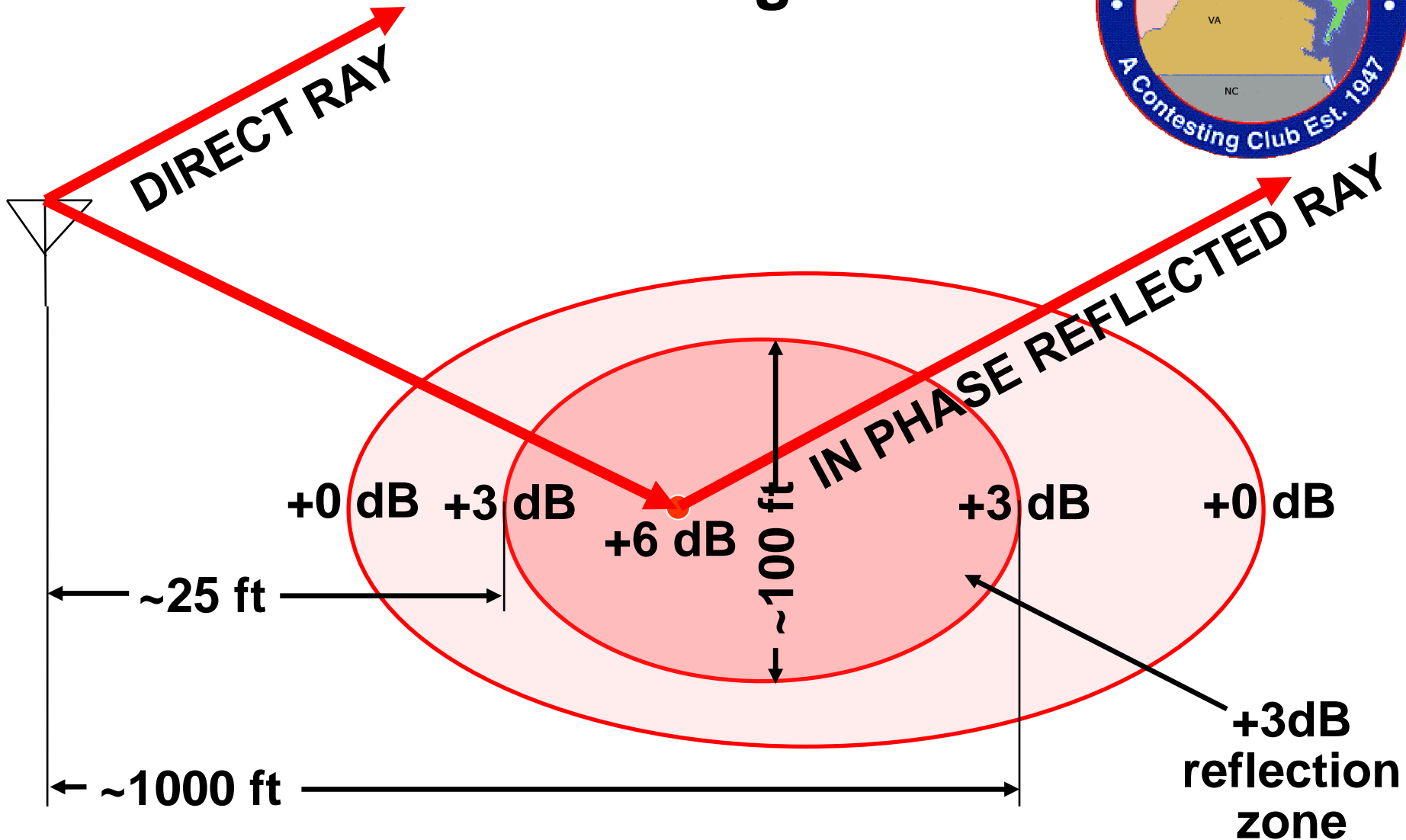
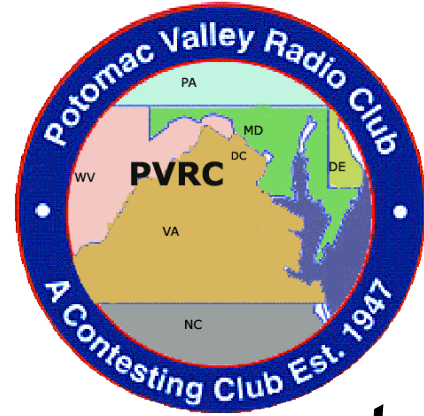

5° Sloping Terrain +3 dB Reflection Zone

6 meter Yagi **25 feet** high

~100 ft of sloping terrain over 1000 ft

DIRECT RAY 5° elevation angle

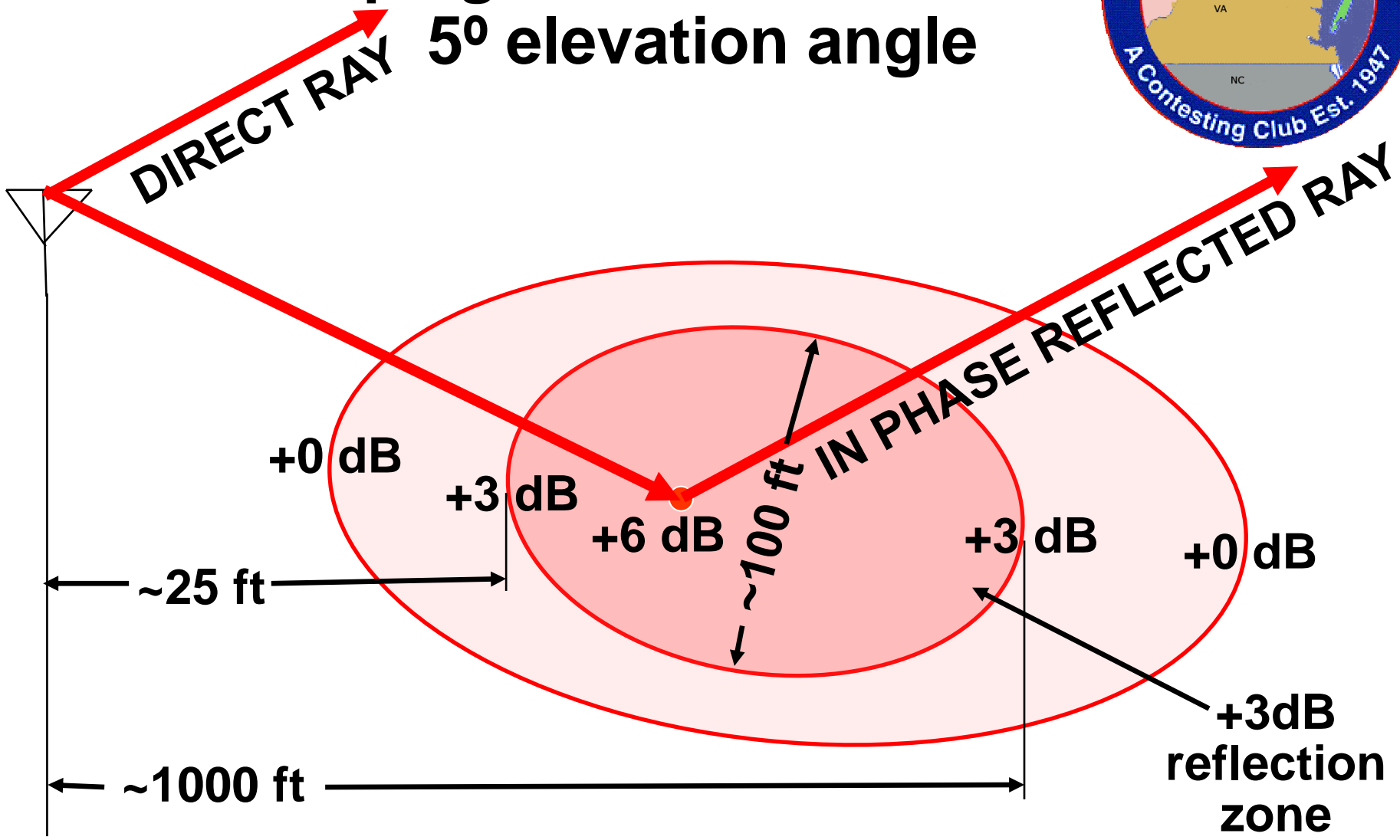
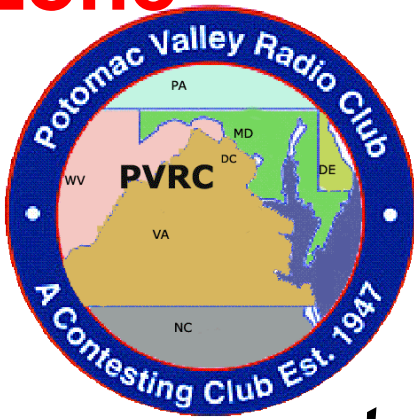

High Performance Short Yagis

light weight and small wind area

Gain and front-to-rear ratio

Source: VE7BQH charts (December 2021)

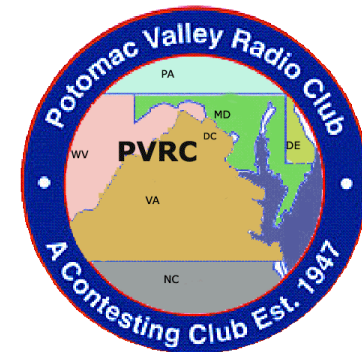

| Type | Elements | Gain dBd | Front to Rear Ratio | Boom Length | Cost |
|----------------------|----------|-------------|------------------------|----------------|--------|
| M2 6M3 | 3 | 6 | 13 dB | 7 ft | \$299 |
| EAntenna 50LFA4 | 4 | 7 | 21 | 10 | \$260 |
| Directive Sys JX5-50 | 5 | 8 | 17 | 13 | \$240 |
| YU7EF EF0605C | 5 | 8 | 24 | 14 | - |
| G0KSC 4.4m 5LFA | 5 | 8 | 19 | 14 | \$225+ |
| EAntenna 50LFA5 | 5 | 8 | 21 | 14 | \$300 |

M2 6M3 Lightweight Yagi

3 Element T-matched Yagi

7 Foot Boom 6 Pounds

6 dBd Gain 13 dB F/R Ratio

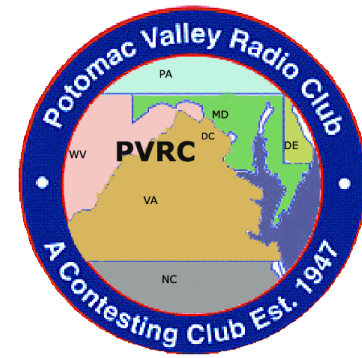

EAntenna 50LFA4

4 Element Loop Fed Yagi
10 Foot Boom 13 Pounds
7 dBd Gain 21 dB F/R Ratio

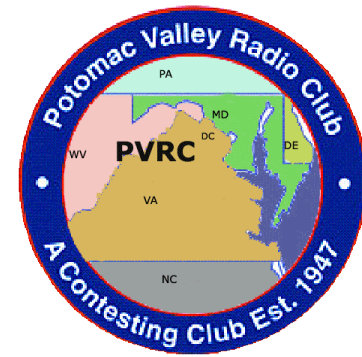

www.dxengineering.com/parts/ean-r2010106

EAntenna 50LFA5

5 Element Loop Fed Yagi
14 Foot Boom 17 Pounds
8 dBd Gain 21 dB F/R Ratio

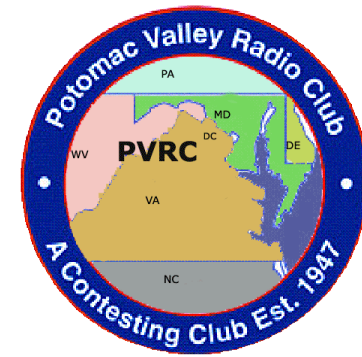

YU7EF EF0605C

5 element split dipole feed Yagi
14 Foot Boom 17 Pounds
8 dBd Gain 24 dB F/R Ratio

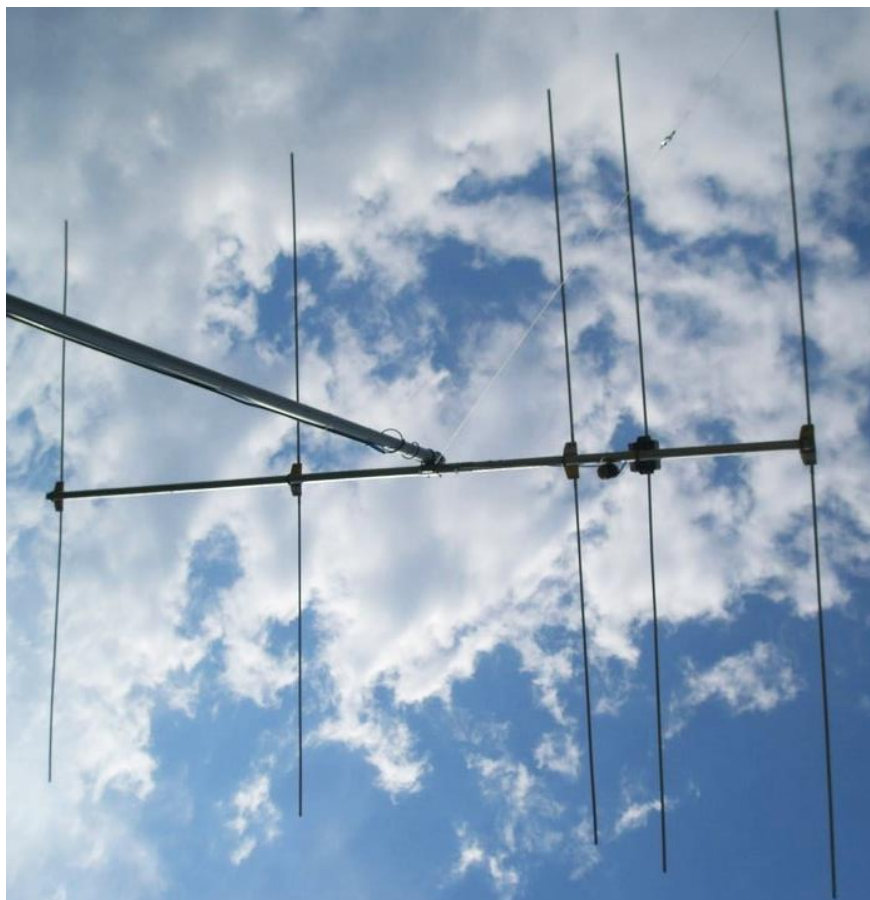
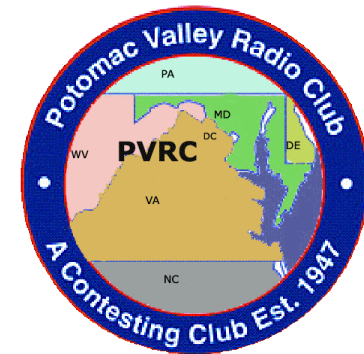

www.yu7ef.com/ef0605c.htm

G0KSC 5LFA

5 Element Loop Fed Yagi

14 Foot Boom 13 Pounds

8 dBd Gain 19 dB F/R Ratio

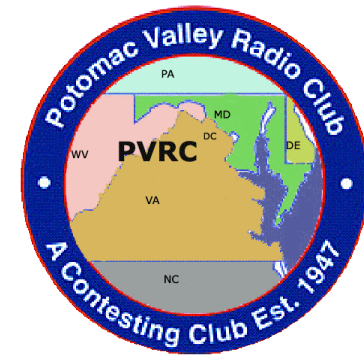

www.g0ksc.co.uk/50mhz-lfa-yagis/5el-44mtr-boom-lfa.html

Higher Performance Long Yagis

Long boom LFAs improve front-to-rear ratio

Gain and front-to-rear ratio

Source: VE7BQH charts (December 2021)

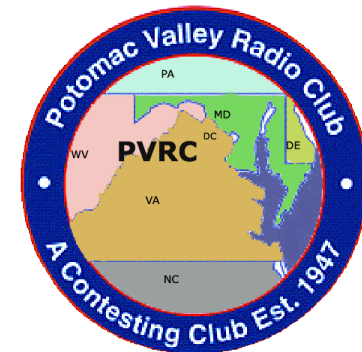

| Type | Elements | Gain dBd | Front to Rear Ratio | Boom Length | Cost |
|------------------|----------|-------------|------------------------|----------------|--------|
| G0KSC 6.2m 6LFA | 6 | 9 | 30 dB | 21 ft | \$406+ |
| Innov 6.83m 6LFA | 6 | 10 | 27 | 22 | \$447+ |
| EAntenna 50LFA6 | 6 | 10 | 27 | 23 | \$460 |
| G0KSC 8.9m 7LFA | 7 | 11 | 25 | 29 | \$554+ |
| EAntenna 50LFA7 | 7 | 11 | 26 | 31 | \$500 |
| M2 6M7JHV | 7 | 11 | 21 | 31 | \$525 |
| Innov 8LFA | 8 | 11 | 29 | 39 | \$812+ |

G0KSC 6LFA

6 Element Loop Fed Yagi
21 Foot Boom 14 Pounds
9 dBd Gain 30 dB F/R Ratio

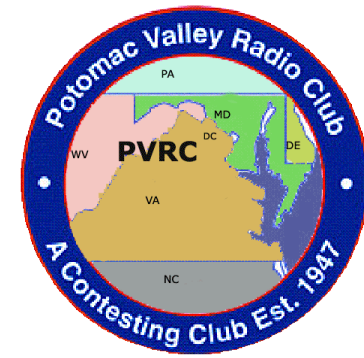

www.g0ksc.co.uk/50mhz-lfa-yagis/6el-64mtr-boom-lfa.html

InnovAntennas 6.83m 6LFA

6 Element Loop Fed Yagi

22 Foot Boom 14 Pounds

10 dBd Gain 27 dB F/R Ratio

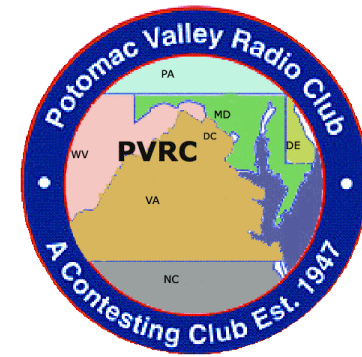

Eantennas 50LFA6

6 Element Loop Fed Yagi

23 Foot Boom 30 Pounds

10 dBd Gain 27 dB F/R Ratio

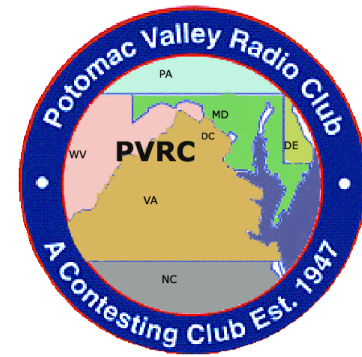

www.dxengineering.com/parts/ean-r2010108

G0KSC 8.9m 7LFA

**7 Element Loop Fed Yagi
29 Foot Boom 33 Pounds
11 dBd Gain 25 dB F/R Ratio**

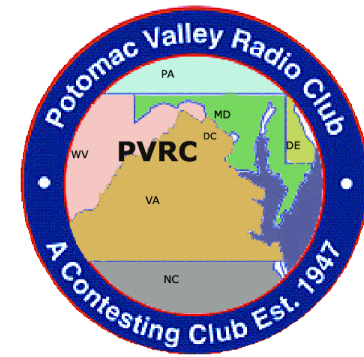

www.g0ksc.co.uk/7el-low-noise-lfa.html

Eantennas 50LFA7

6 Element Loop Fed Yagi

31 Foot Boom 50 Pounds

11 dBd Gain 26 dB F/R Ratio

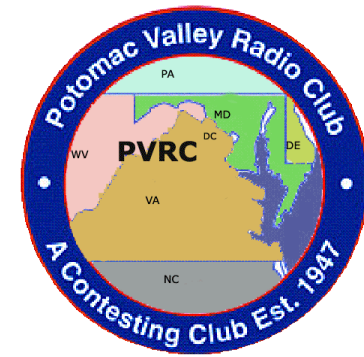

www.dxengineering.com/parts/ean-r2010111

M2 6M7JHV

7 Element T-matched Yagi
26 Foot Boom 18 Pounds
11 dBd Gain 21 dB F/R Ratio

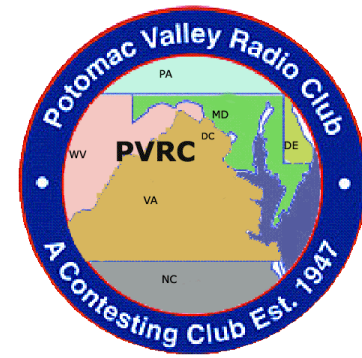

InnovAntennas 8LFA

8 Element Loop Fed Yagi
38 Foot Boom 40 Pounds
11 dBd Gain 29 dB F/R Ratio

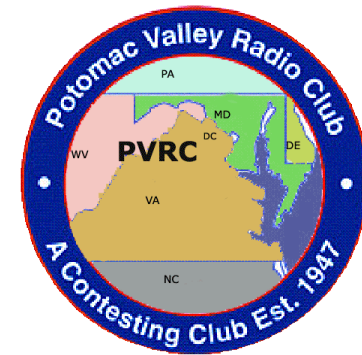

www.innovantennas.com/en/shop-page/190/3/vhf-uhf-ham-radio-antennas/50mhz-yagis-all/8-element-50mhz-lfa2-yagi-11-67mlInnovAntennas%20shop.html

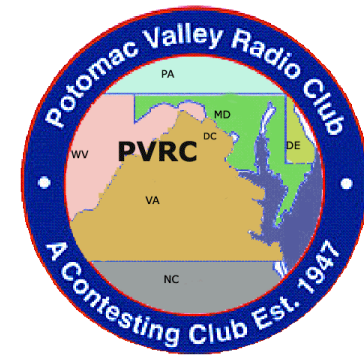

Yagi Element Construction



Center of each Yagi element:

6 feet of 0.5" diameter x 0.058" wall aluminum tubing

www.dxengineering.com/parts/dxe-at1205

Tips of each Yagi element:

2 feet of 0.375" diameter x 0.058" wall aluminum tubing

www.dxengineering.com/parts/dxe-at1189

Protecting Yagi Element Joints

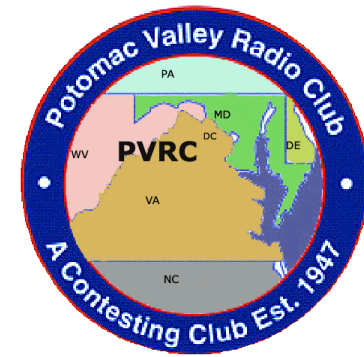

Anti-Sieze and Anti-Corrosion Lubricant



Assures RF conductivity

Prevents oxidation and corrosion

No long-term drying and caking like many other lubricants

Easy Yagi element disassembly

Effortless cleaning of parts

www.dxengineering.com/parts/jtl-12555

Yagi Boom Construction

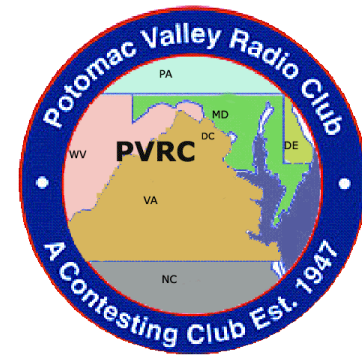

12 foot boom: Two 6 ft x 1.5" o.d. x 0.058" wall aluminum tubing
www.dxengineering.com/parts/dxe-at1488

18 foot boom: Three 6 ft x 1.5" o.d. x 0.120" wall aluminum tubing
www.dxengineering.com/parts/dxe-at1311

24 foot boom: Four 6 ft x 2" o.d. x 0.058" wall aluminum tubing
www.dxengineering.com/parts/dxe-at1492

Square aluminum tubing makes precise element mounting easier
use 1.5 inch square tubing for a 12 foot boom
use 2.0 inch square tubing for a 24 foot boom
www.metalsdepot.com/aluminum-products/aluminum-square-tube

Stauff Clamps

For mounting Yagi elements to a horizontal plate attached to a boom

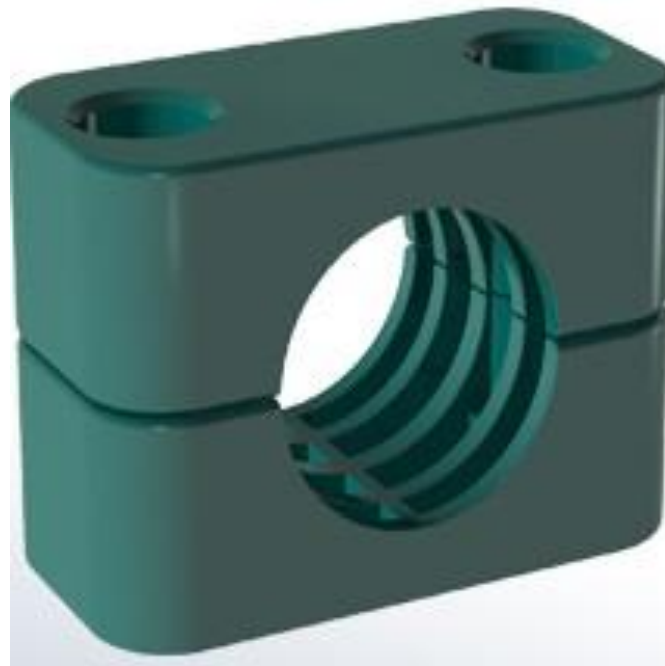
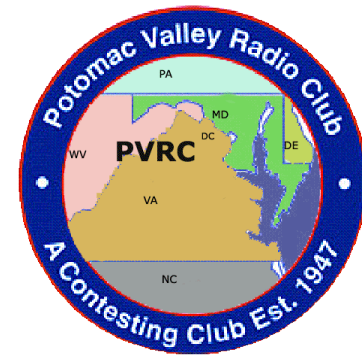

[www.wilson-company.com/product/30127pp/
two-bolt-heavy-duty-clamp-body-only](http://www.wilson-company.com/product/30127pp/two-bolt-heavy-duty-clamp-body-only)

RFI Suppression Choke

necessary at the feed point
of a Yagi balanced driven element

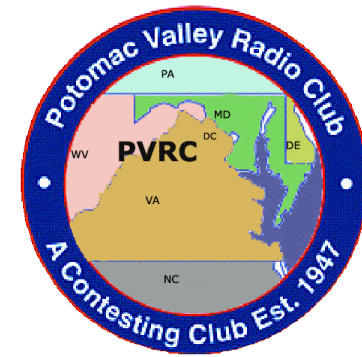

Unbalanced driven element current
degrades Yagi sidelobe performance

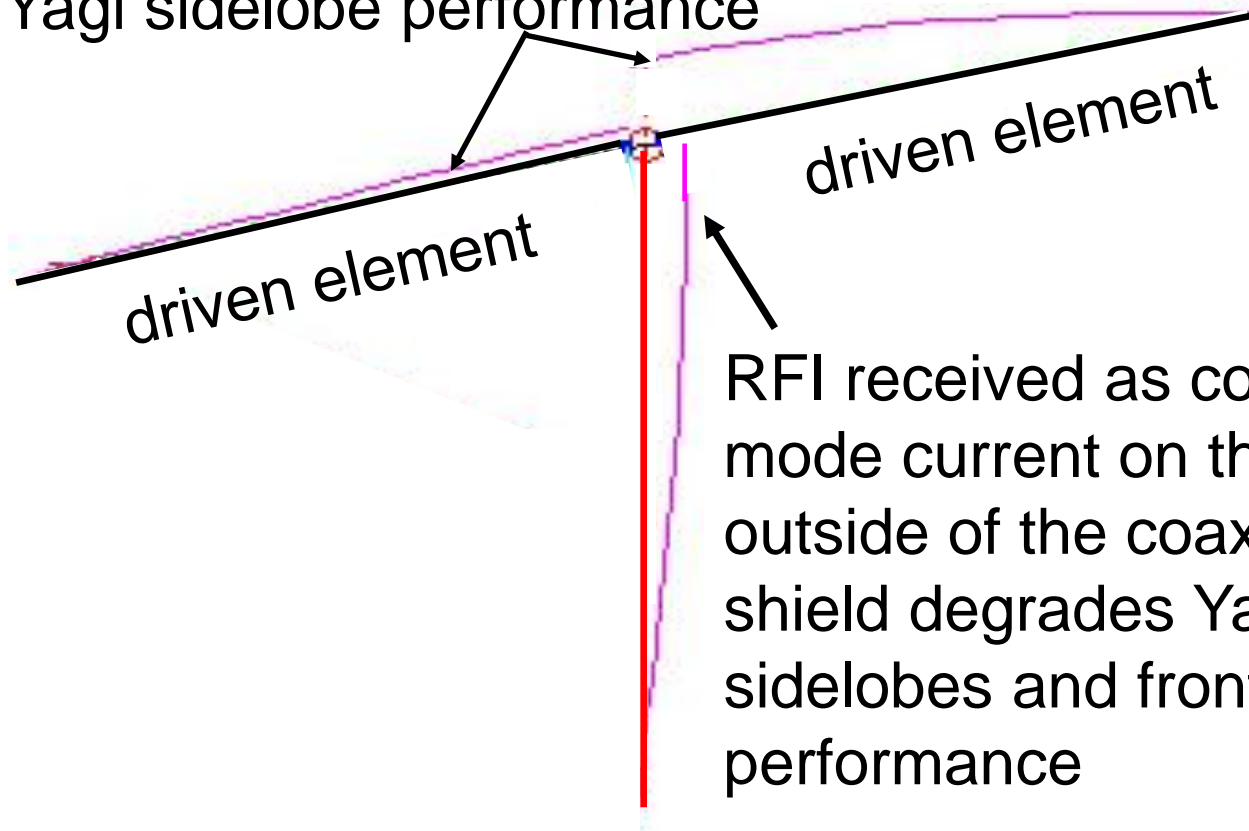

RFI Suppression Choke

Coiled RG-213 coaxial cable
suitable for quiet RFI environments

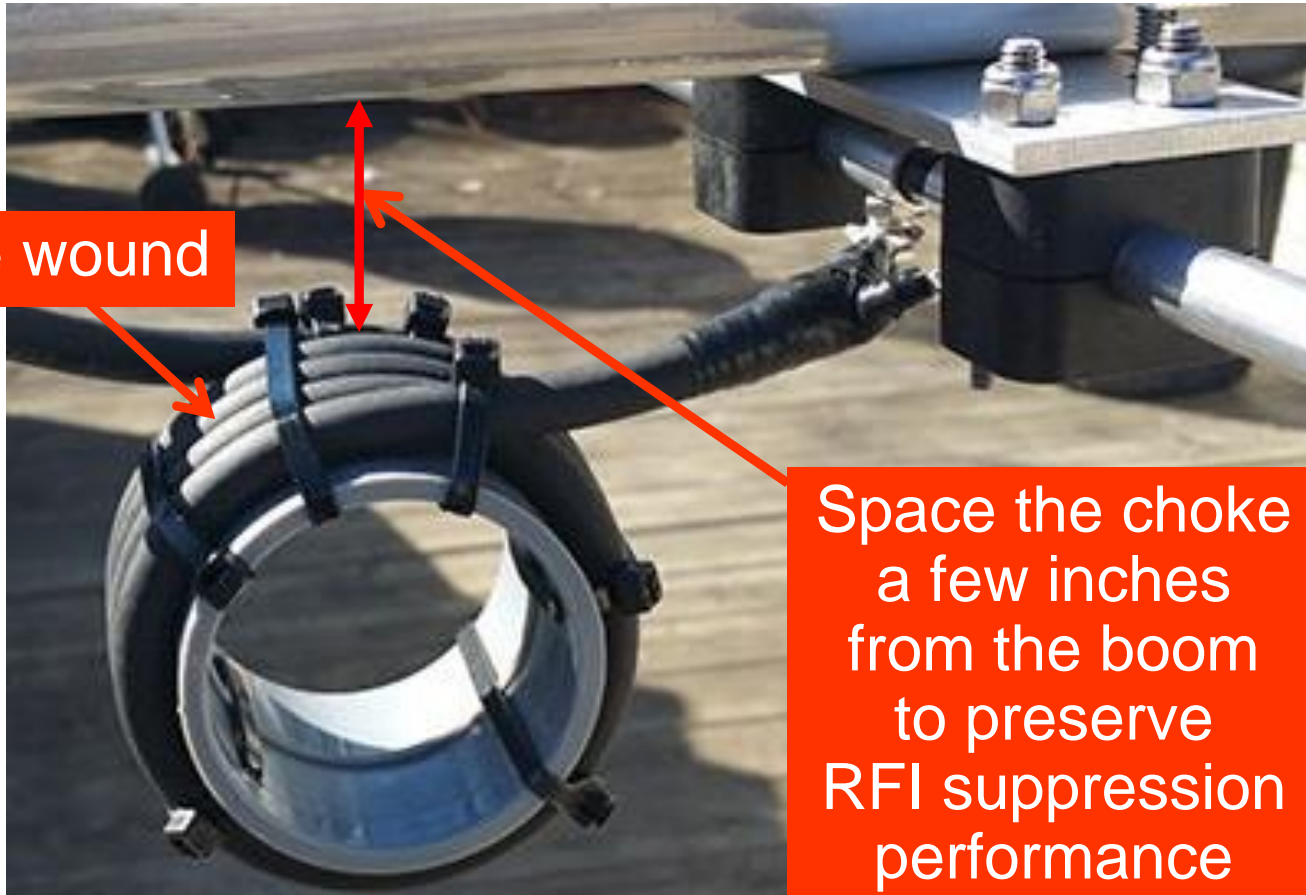
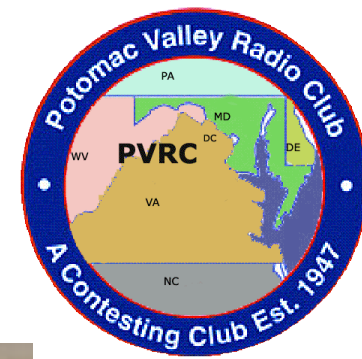

Four turns of RG-213 wound on a 2.5 inch diameter form
The builder must measure for choke resonance near 50 MHz

RFI Suppression Choke

20 mix-31 round cable ferrite cores
installed over RG-213

Suitable for moderate RFI environments

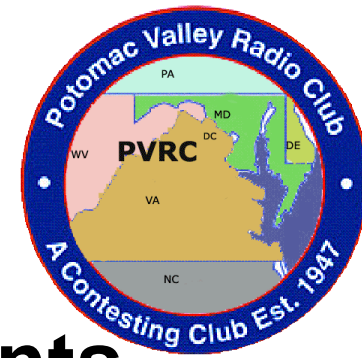

Space the choke
a few inches
from the boom
to preserve
RFI suppression
performance

DX Engineering DXE-CB31-500-10 ferrite cores
www.dxengineering.com/parts/dxe-cb31-500-10

www.innovantennas.com/index.php?option=com_content&view=article&id=3&Itemid=189&lang=en

RFI Suppression Choke

five mix-31 clamp-on ferrite beads
optimized for severe RFI environments

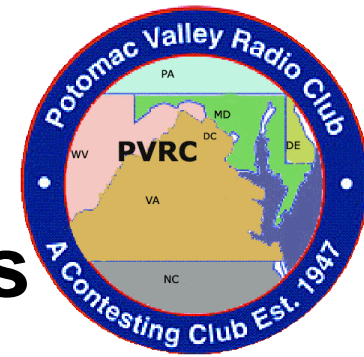

before installation



audiosystemsgroup.com/ChokesVHF.pdf

Low Loss Coaxial Cable

Really pays off on 6 meters

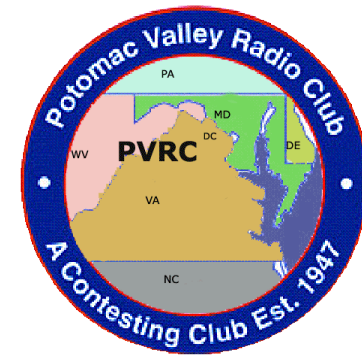

| | | |
|----------|---------------|------------------------|
| RG-8X | flexible coax | 40 feet <i>per dB</i> |
| RG-213 | flexible coax | 60 feet <i>per dB</i> |
| LDF4-50A | 1/2" hardline | 200 feet <i>per dB</i> |
| LDF5-50A | 7/8" hardline | 400 feet <i>per dB</i> |

LDF4-50A has one dB less loss than RG-213 at a cable length of only 85 feet

LDF4-50A has two dB less loss than RG-213 at a cable length of only 170 feet

LDF5-50A has one dB less loss than LDF4-50A at a cable length of 475 feet

Reliable 6 Meter Coaxial Cable Connectors

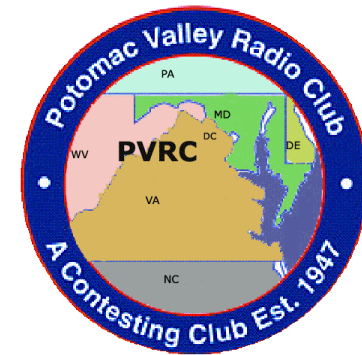

N and UHF connectors are commonly used

- both have insignificant measurable loss

High quality silver plated PL-259 UHF connectors

- much more reliable center pin mating force than N connectors

Common N connector failures caused by pin installation errors

- unreliable mating caused by insufficient pin length and pin pullback
- damage caused by excess pin length and axial pin misalignment

Captive pin N connectors solve N connector reliability issues

- assures the necessary ± 0.020 inch ($\pm 1/2$ mm) pin depth tolerance
- assures axial pin alignment and centering
- prevents pin pullback

Avoid using adapters as much as possible

- use only name-brand silver plated adapters
- never use nickel plated or “astro-plated” connectors and adapters
- never use cheap import “no name” adapters and connectors

Wrench tighten your all of your PL-259 connectors (~1/4 turn)

**Avoid saving a few dollars on cheap unbranded
coaxial cable connectors and adapters**

Amphenol 83-1SP PL-259 UHF Male Connector

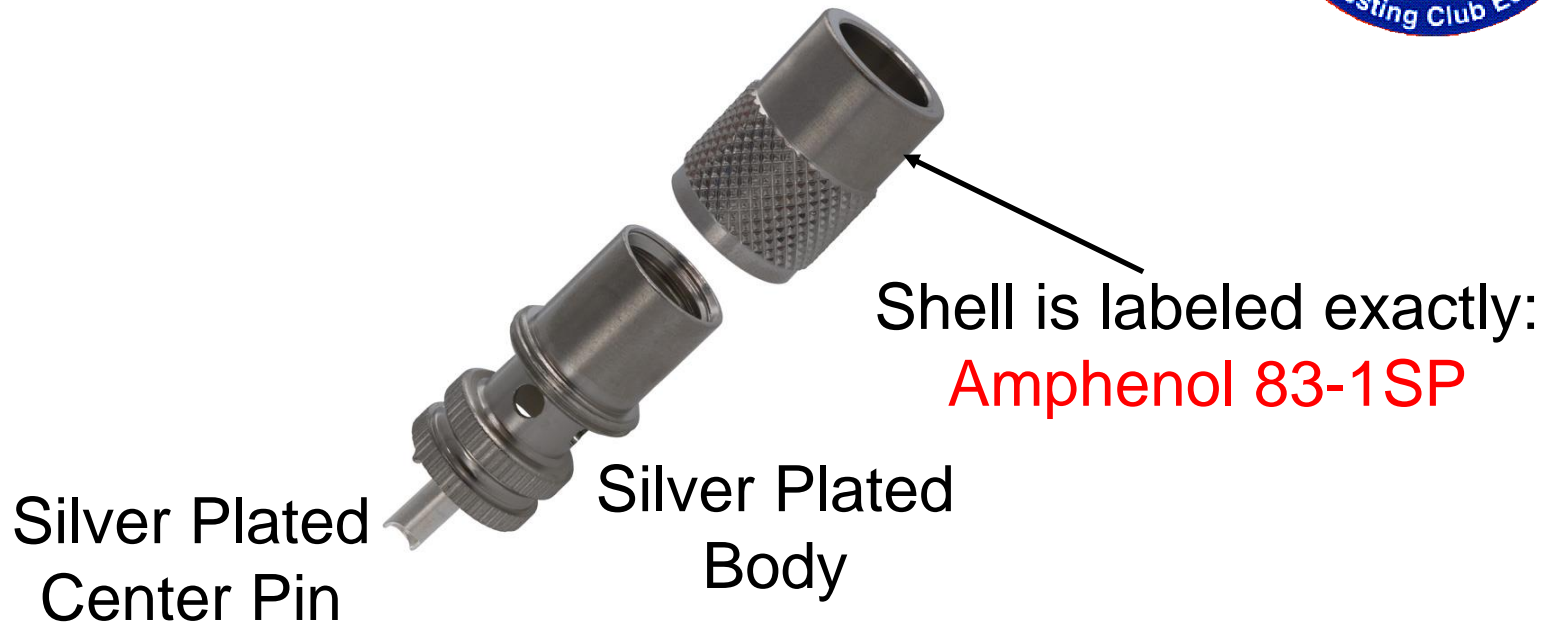
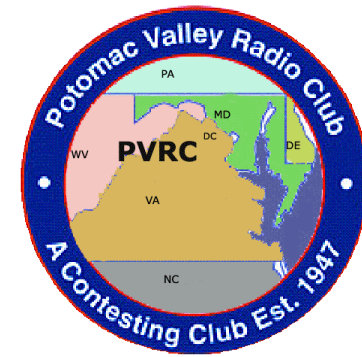

www.dxengineering.com/parts/aml-83-1sp

The Amphenol 83-1SP is an excellent connector for 6 meters

Waterproofing the end of RG-213 coaxial cable

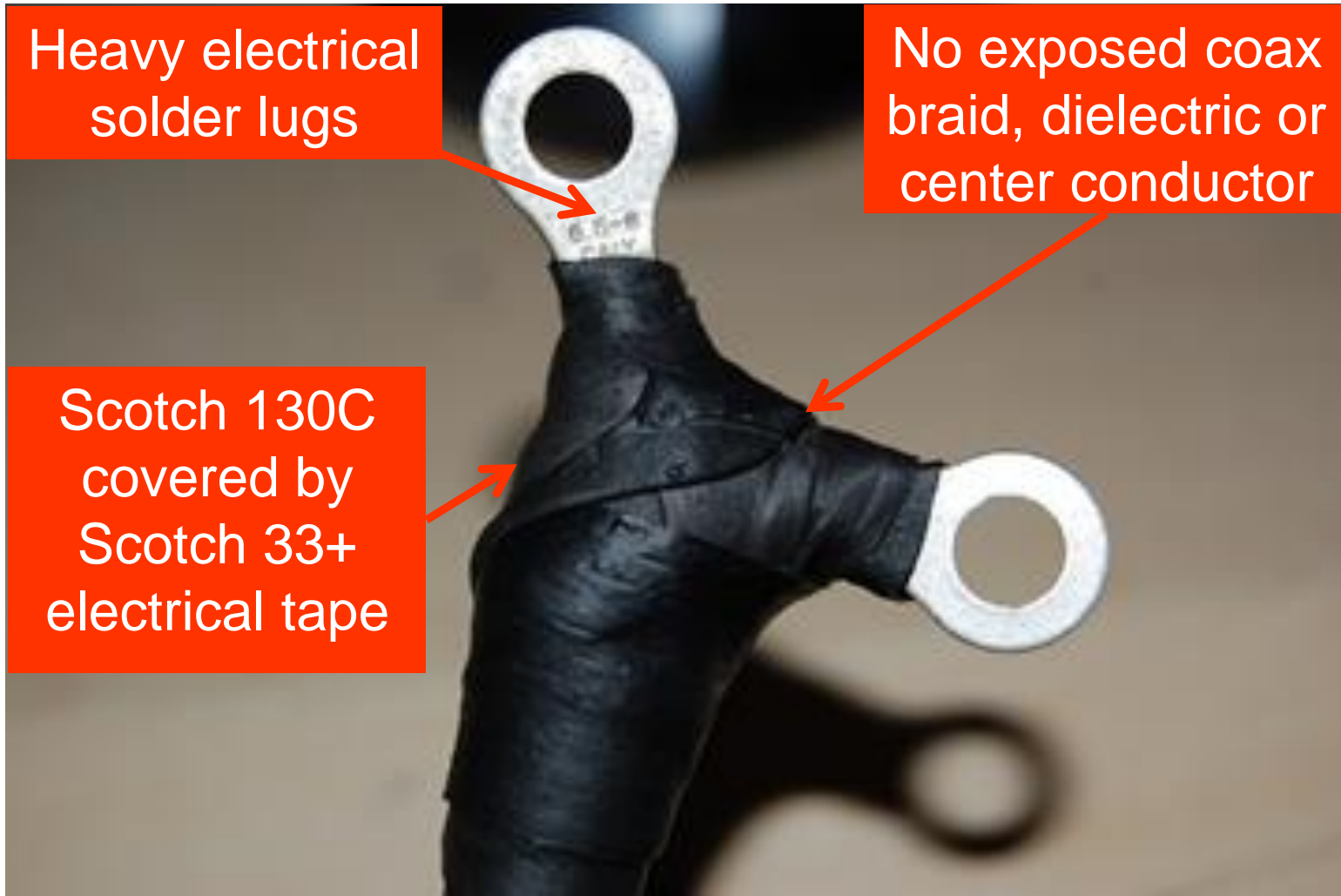
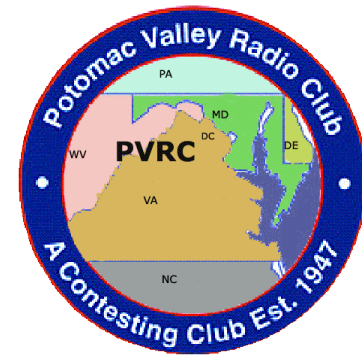

Yagi Driven Element

Waterproof, shakeproof and corrosion resistant driven element connections

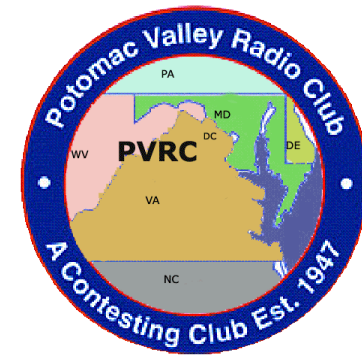

Driven Element Connections

Waterproof and Corrosion Resistant

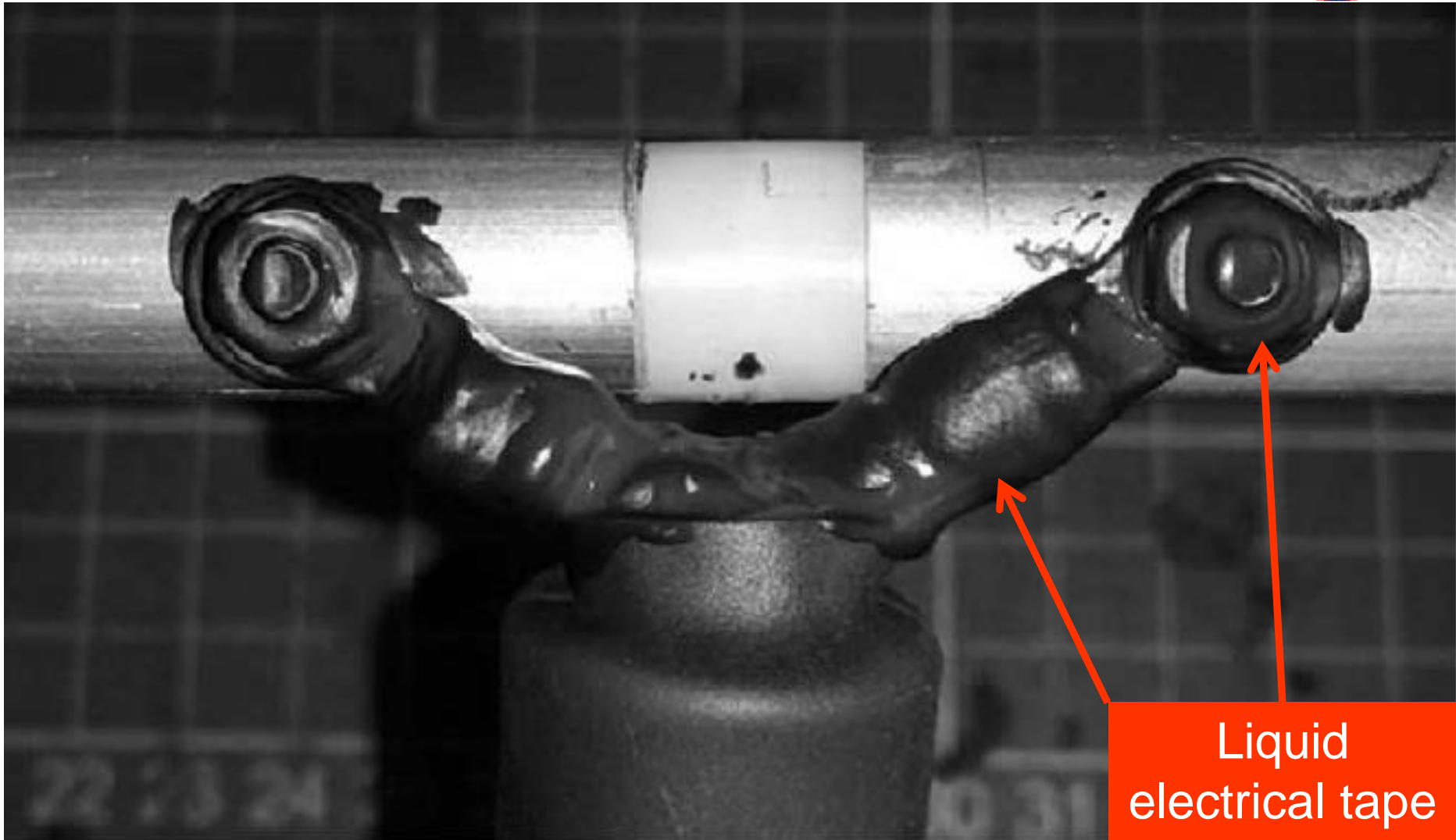
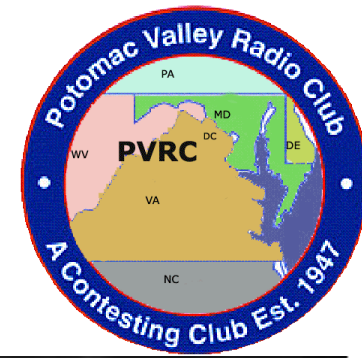

Liquid
electrical tape

Waterproof your Connectors!

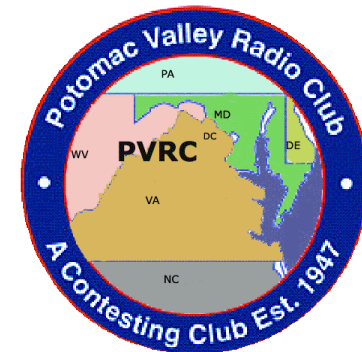

Cover your connectors with **two 50% overlapped layers** of Scotch 130C self-vulcanizing linerless rubber splicing tape

- stretched to 50% of its original width
- sticky side facing out

Cover the Scotch 130C tape with **two 50% overlapped layers** of Scotch Super 33+ vinyl electrical tape

www.homedepot.com/p/3M-Scotch-3-4-in-x-30-ft-Linerless-Rubber-Splicing-Tape-41717-BX-10/205523418

www.homedepot.com/p/3M-Scotch-Super-33-3-4-in-x-66-ft-Electrical-Tape-06132-8/300666852