

Easy to Build Low Band Receiving Antennas for Small and Large Lots

- Small antennas
- High performance antennas
- Diversity reception

Frank Donovan
W3LPL

• CTU •
CONTEST
UNIVERSITY

ICOM[®]

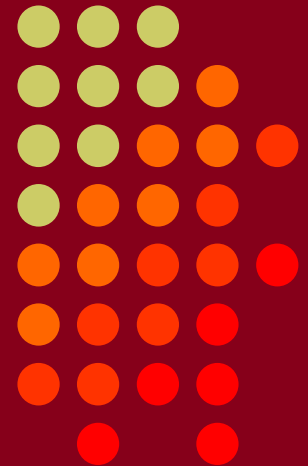

160 Meter Propagation

What's So Hard About Communicating Near or Below the Lowest Usable Frequency?

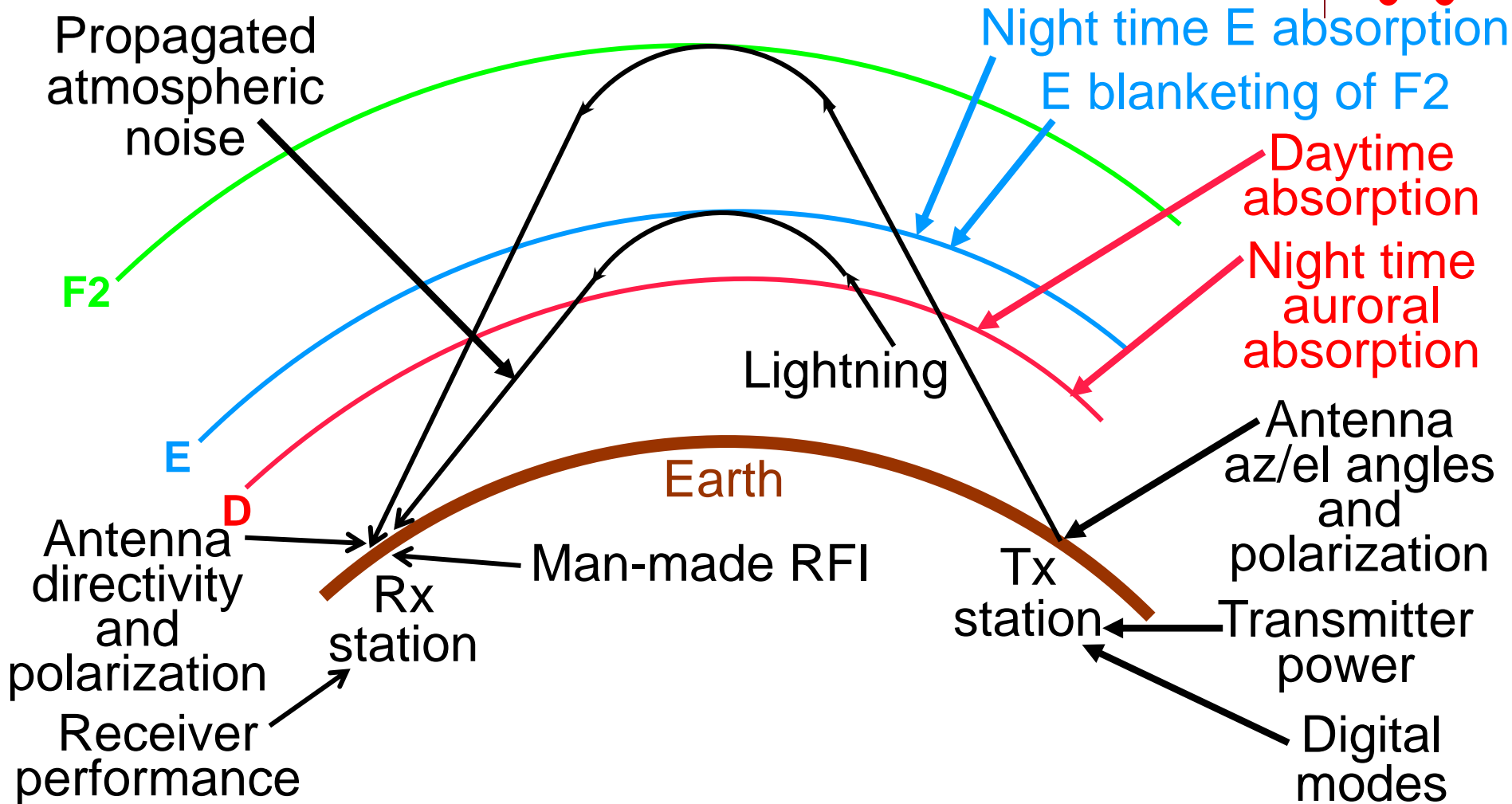

Why Receiving Antennas?



Much better performance than most transmitting antennas

- much lower cost
- greatly reduced footprint
- greatly reduced height (7 to 25 feet)
- good directivity on as little as 650 to 2500 square feet
- excellent directivity on less than an $\frac{1}{4}$ acre
- directivity equivalent to a 5 element Yagi on less than $\frac{3}{4}$ acre
- greatly reduced mutual coupling between individual receiving verticals
- greatly reduced need for efficient matching and extensive radial systems

High performance arrays perform equivalent to a 5 element Yagi!

Combining two antennas with a variable phase controller

- steerable nulls
- optimizes the front-to-back ratio of phased Beverages and phased verticals

Diversity reception with dual phase locked receivers



Receiving Directivity Factor (RDF)

proven measure of receiving antenna performance

Compares forward gain at the desired azimuth and elevation angle to average gain over the entire hemisphere

- EZNEC computes antenna RDF

Assumes noise is equally distributed over the entire hemisphere

- an invalid assumption for suburban and especially urban locations where noise is often concentrated on the horizon at specific azimuths

Assumes that RFI is more than 1000 feet away, in the far field of the antenna

- where the antenna pattern of large antennas is fully formed, and
- RFI sources look more like a point sources

www.w8ji.com/receiving

Re-radiation from antennas, towers and power lines within about 1000 feet can degrade your actual RDF especially for high RDF arrays

Small Receiving Antennas

4 to 11 dB RDF



- 4 dB: Bidirectional 8 foot diameter “magnetic” loop close to the ground
- 5 dB: Single vertical antenna (short vertical or $\frac{1}{4}$ wavelength vertical)
- 6 dB: 225 foot Beverage on Ground (BOG) **poor low angle sensitivity**
- 7 dB: 250 foot Beverage about 7 feet high better low angle response
- 7 dB: Unidirectional terminated small loop close to the ground
 - flag, pennant, EWE, VE3DO
- 8 dB: Two switchable small terminated loops at right angles to each other
 - K9AY Array
 - Shared Apex Loop Array
- 8 dB: Pair of 250 foot staggered Beverages about 7 feet high
- 9 dB: Two phased short verticals with 60 to 80 foot spacing
- 9 dB: Triangle array of phased short verticals with 60 to 80 foot spacing
- 11 dB: Vertical Waller Flag: two phased vertical loops close to the ground

High Performance Receiving Antennas

10 to 14 dB RDF



- 10 dB: Pair of 400 foot staggered Beverages about 7 feet high
- 10 dB: 500 to 600 foot Beverage about 7 feet high **ideal for both 160 and 80 meters**
- 11 dB: Two or three close spaced 500 to 600 foot Beverages, staggered 125 feet
- 11 dB: Vertical Waller Flag: 2 phased close spaced vertical loops close to the ground
- 12 dB: 750 to 1000 foot Beverage about 7 feet high **too long for 80 meters**
- 12 dB:** 4 square array of active or passive short verticals **80 x 80 ft**
- 12 dB:** 3 element YCCC tri-band array of short active verticals **120 ft long**
- 12 dB:** 5 element YCCC tri-band array of short active verticals **84 x 84 ft**
- 12 dB:** 9-circle YCCC tri-band array of short active verticals **120 ft diameter**
- 12 dB: Horizontal Waller Flag: 2 phased horizontal loops **100 feet high minimum**
- 13 dB: BSEF array of 4 short verticals switchable in two directions 350 ft x 65 ft
- 13 dB: 8-circle array of short verticals with 106° phasing 200 ft diameter
- 13 dB: 8-circle BSEF array of short passive verticals 350 ft diameter + radials
- 14 dB: Four broadside/end-fire 750-1000 foot Beverages 750 ft x 330 ft

Large antennas are less effective than small antennas for suppressing local RFI sources within about 1000 feet

Single Small Loop Antennas

4 - 7 dB RDF 120 to 150° 3 dB beam width



8 foot diameter bidirectional “magnetic” loop

4 dB RDF

- bi-directional 150° 3 dB beam width
- 24 dB deep vertically polarized null with very narrow 2° null width
- must be installed close to the ground to optimize the depth of the null by suppressing horizontally polarized signals
- a specialized antenna for steering a deep narrow null onto the RFI source onto a single ground wave propagated vertically polarized RFI source
- a 17 foot diameter loop has better DX sensitivity but only 20 dB deep nulls

Unidirectional terminated small loop antennas

6 - 7 dB RDF

- Flag Pennant EWE K9AY VE3DO
- 120° 3 dB beam width

Mechanically rotatable unidirectional terminated small loop antenna

- rotatable flag
- 120° 3 dB beam width

6 - 7 dB RDF

Two End-Fire Phased Vertical Loops 1919

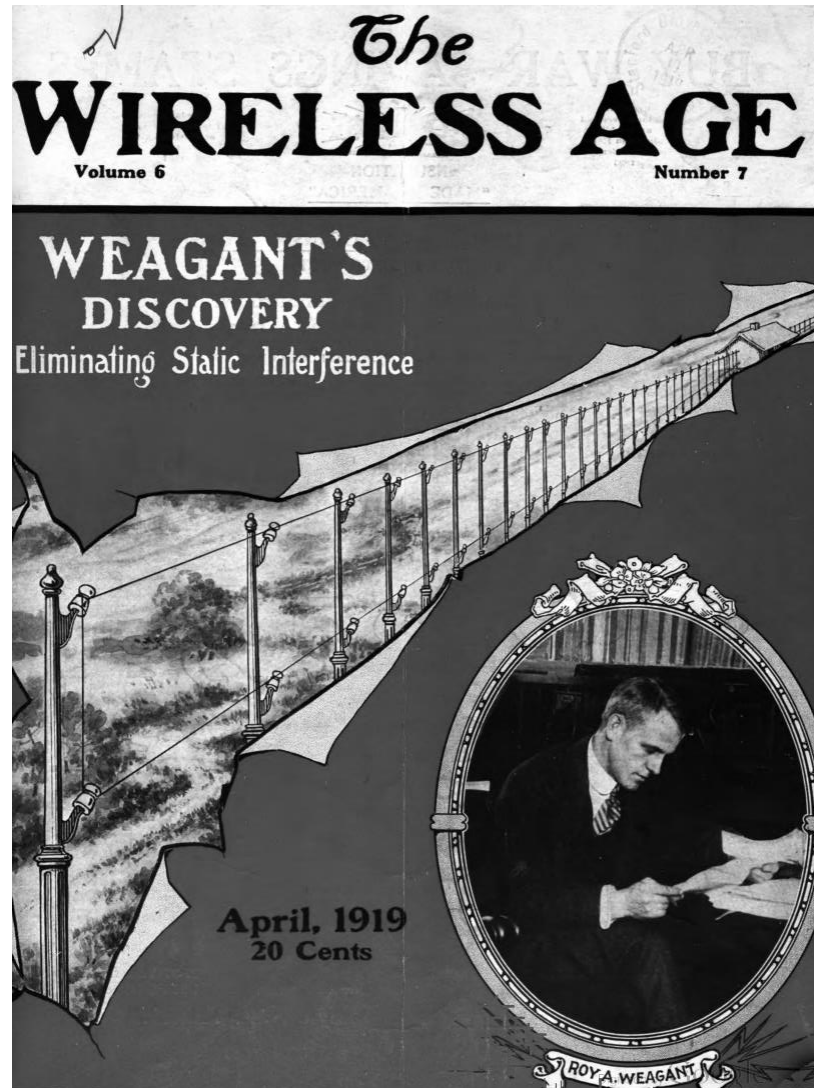

◦ CTU ◦

CONTEST
UNIVERSITY

worldradiohistory.com/UK/Wireless-Age/Wireless-Age-1919-Apr.pdf

ICOM[®]

Two End-Fire Phased Vertical Loops 1919

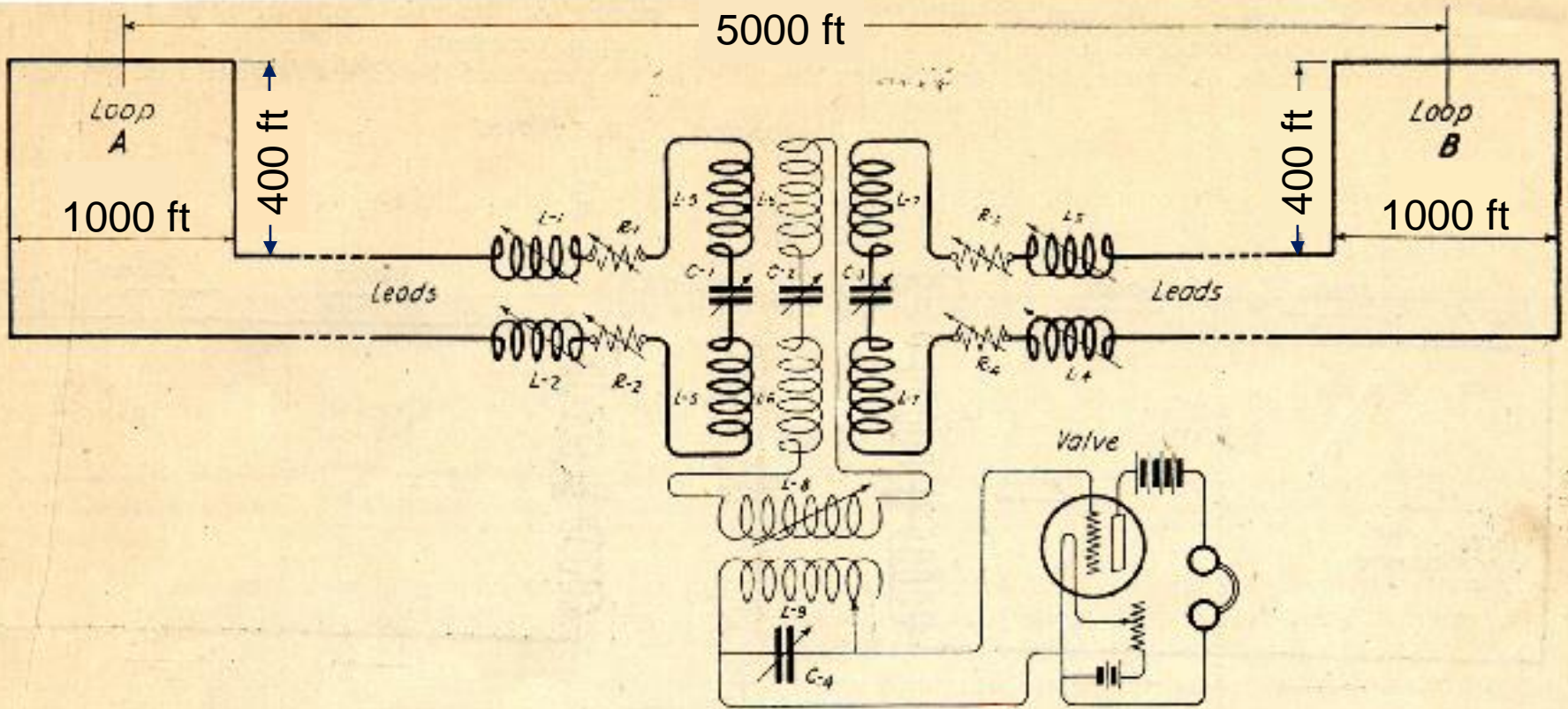

Figure 6—An early form of Weagant's system for eliminating static interference showing two single turn loop antennae spaced 5,000 feet apart. Each loop was 1,000 feet long at the base and 400 feet high. The leads from each loop were connected to the primary coils, L-5 and L-7, of the radio goniometer which were coupled to the secondary coil L-6. By rotating L-6, a position was found where the static currents neutralized and the signal currents were retained. This apparatus and antennae permitted the reception of signals from stations in Europe under conditions of static interference which with ordinary receiving apparatus and antennae would render reception impossible.

Wireless Age April 1919, Page 11

◦ CTU ◦

CONTEST
UNIVERSITY

worldradiohistory.com/UK/Wireless-Age/Wireless-Age-1919-Apr.pdf

ICOM

Arrays of Two Small Loops

8 - 11 dB RDF 80 to 120° 3 dB beam width



Electrically switchable compact arrays of two small loops

- two switchable K9AY loops installed close to the ground
- Shared Apex Loop Array installed close to the ground
- 120° 3 dB beam width

8 dB RDF
8 dB RDF

350 ft broadside spaced small terminated loops

9 - 10 dB RDF

- Flag pennant EWE K9AY VE3DO installed close to the ground
- 80° 3 dB beam width

Mechanically rotatable array of two end-fire close spaced small loops

- Vertical Waller Flag: 2 phased vertical loops close to the ground 11 dB RDF
- Horizontal Waller Flag >100 feet high - superb RFI suppression 11 dB RDF
- 80 degree 3 dB beam width
- Close spaced end-fire small loops produce extremely low signal levels
 - requires at least 40 dB of preamp gain and 2 dB preamp noise figure or less
 - extreme attention to common mode signal suppression – invest in ferrites

BOGs and Arrays of BOGs



BOGs have poor low angle sensitivity

6 to 8 dB RDF 60 - 90° 3 dB beam width

BOG 100° 3 dB beam width **6 dB** RDF

- 225 foot wire supported just above **but not on** the surface of the ground

Switchable bi-directional BOG 100° 3 dB beam width **6 dB** RDF

- 225 foot coax cable supported just above **but not on** the surface of the ground

Close spaced staggered BOGs 100° 3 dB beam width **7 dB** RDF

- two or three close spaced BOGs with 125 foot end fire spacing
- significantly improves front-to-back ratio especially if a variable phase controller is used

Two wide spaced BOGs 60° 3 dB beam width **8 dB** RDF

- 350 foot broadside spaced BOGs reduces beam width to 60°

BOGs are very low sensitivity antennas especially at low angles requiring excellent suppression of coaxial cable common mode signals

Beverages and Beverage Arrays

only 7 feet high to suppress horizontally polarized signals
single wire Beverage or two wire reversible Beverage



6 to 14 dB RDF 45 to 120° 3 dB beam width

250 foot Beverage	120° 3 dB beam width	8 dB RDF
400 foot Beverage	100° 3 dB beam width	9 dB RDF
500 to 600 foot Beverage	80° 3 dB beam width	10 dB RDF
600 to 750 foot Beverage	70° 3 dB beam width	11 dB RDF
750 to 1000 foot Beverage	60° 3 dB beam width	12 dB RDF
Staggered Beverage arrays	80° 3 dB beam width	11 dB RDF
<ul style="list-style-type: none">• two or three 500-600 foot Beverages with 125 foot end-fire spacing• significantly improves front-to-back ratio with a variable phase controller		
Broadside Beverage arrays	45 - 60° 3 dB beam width	12-14 dB RDF
<ul style="list-style-type: none">• two Beverages with 350 foot broadside spacing, or• four Beverages with 125 foot end fire spacing and 350 foot broadside spacing• significantly improves front-to-back ratio with a variable phase controller		

1300 Foot Beverage installed by Paul Godley 2ZE

Near the waterfront in Ardrossan, Scotland
During the successful 1921 Transatlantic Tests

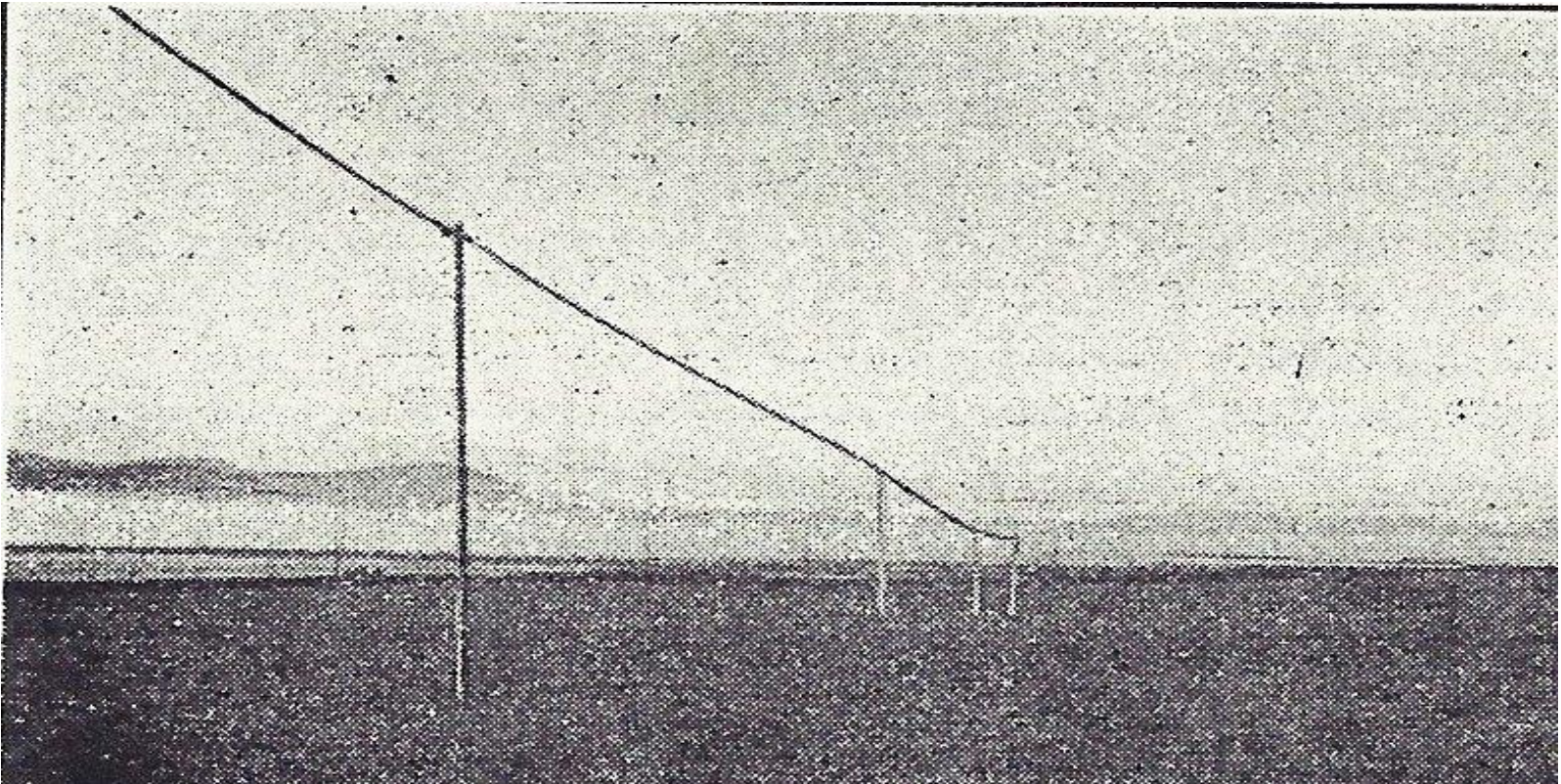

Beverages were all but forgotten by hams for 45 years until
K1PBW re-introduced them to 160 meter DXers in 1967

Arrays of Short Phased Verticals

9 - 14 dB RDF 50 to 135° 3 dB beam width



Active high impedance 20 foot verticals

- capable of multi-band operation with some performance compromise
- no radials
- requires a high input impedance amplifier *at the base of each vertical*

----- or -----

Passive low impedance 25 foot verticals

- mono-band operation only
- *very easy to troubleshoot and repair* *low parts count* *very reliable*
- eight 70 foot or sixteen 35 foot radials *at the base of each vertical*
 - stabilizes the feed point impedance during all weather conditions
 - decouples the coax shield to suppress common mode signals
- four 25 foot umbrella wires
 - reduces the required height to 25 feet
 - increases the array bandwidth
 - or 35 foot verticals with no umbrella wires

Small Diameter Loop Antenna

Eight Foot Diameter “Magnetic” Loop



Excellent for nulling **a single** nearby RFI source

- RFI to be nulled must be vertically polarized and received via ground wave

Superb for precisely locating RFI **very small loops have deeper nulls**

Bi-directional figure-8 pattern **very broad 150° 3 dB beam width**

- Must be installed close to the ground to suppress horizontally polarized signals

Very deep approximately 2° wide nulls off both sides of the loop

- mechanically rotate the loop until the single local RFI source is nulled
- the null is not as deep for skywave propagated signals

Small loop antennas produce very low signal levels

- requires a 20-30 dB gain, very low noise figure preamplifier
- **a low sensitivity receiving antenna for DX, limited by preamp noise figure**

All attached cables must be choked to suppress common mode signals

- install common mode chokes on the coaxial feedline and preamp power cable
- bury cables about 12 inches deep for optimum null depth

Avoid re-radiated signals from nearby antennas and power lines

- locate the antenna as far as possible from other antennas and power lines

8 Foot Diameter Loop Antenna

4 dB RDF 150° 3 dB beam width deep 2° nulls

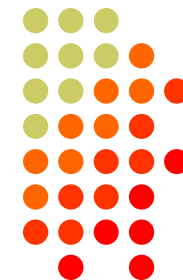

Inexpensive and very easy to build and use

Good compromise size with 24 dB null depth and fairly good sensitivity

24 dB nulls 2° wide broadside to the loop for local RFI suppression

Very broad 150° figure-8 **bidirectional** 3 dB beam width

Poor sensitivity for weak DX signals

Needs a preamplifier with 20-30 dB gain and 2 dB noise figure

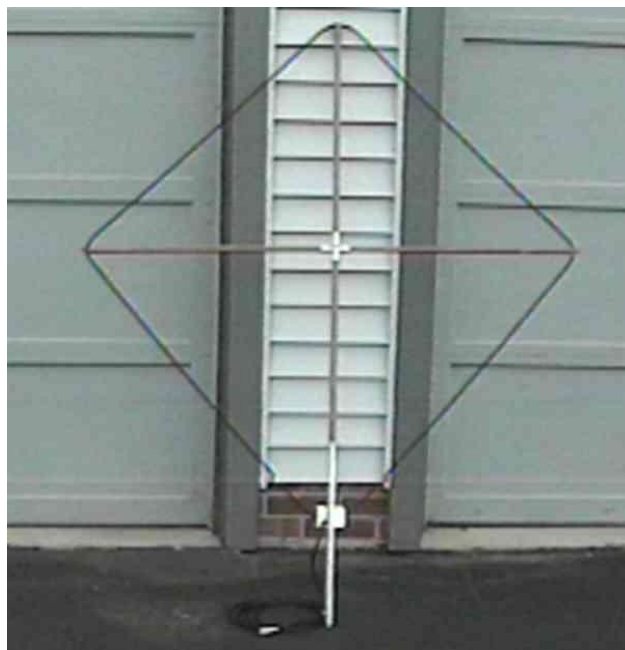

Electrically Steerable Small Loops



- Two K9AY loops
 - switchable in four directions
 - footprint is only 25 x 25 feet and 25 feet tall
 - **120° 3 dB beam width**
 - 7 dB RDF
- Shared Apex Loop Array
 - switchable in eight directions
 - footprint is only 50 x 50 feet and 25 feet tall
 - **75° 3 dB beam width**
 - 8 dB RDF
- **All small loop antennas produce very low signal levels**
 - a high gain, low noise figure preamplifier is essential
 - requires very careful attention to choking unwanted common mode signals
 - choke the coaxial cable feed line and filter the control cable and power cable
 - bury the cables about 12 inches deep for best unwanted signal suppression
- Avoid re-radiated signals from nearby antennas, towers and power lines
 - locate the antenna as far as possible from antennas, towers and power lines

Two K9AY Loops

7 dB RDF in only 625 square feet
very small 25 x 25 foot square x 25 feet high
switchable in four directions
120° 3 dB beam width



Shared Apex Loop Array

8 dB RDF in only 2500 square feet

50 x 50 foot square x 25 feet high
switchable in eight directions

75° 3 dB beam width



Waller Flag Array – Vertical or Horizontal

11 dB RDF in only 30 feet of length

Two small terminated loops with very close end-fire phasing

For most locations: 14 feet tall and 30 feet long

For quiet locations: 20 feet tall and 50 feet long

80° 3 dB beam width

Requires a 30-40 dB gain preamp with very low 2 dB noise figure

A horizontal Waller Flag must be at least 100 feet high but higher is better



Single Wire Beverage Antenna 1920



H. H. BEVERAGE.
RADIORECEIVING SYSTEM.
APPLICATION FILED APR. 10, 1920.

1,381,089.

Patented June 7, 1921

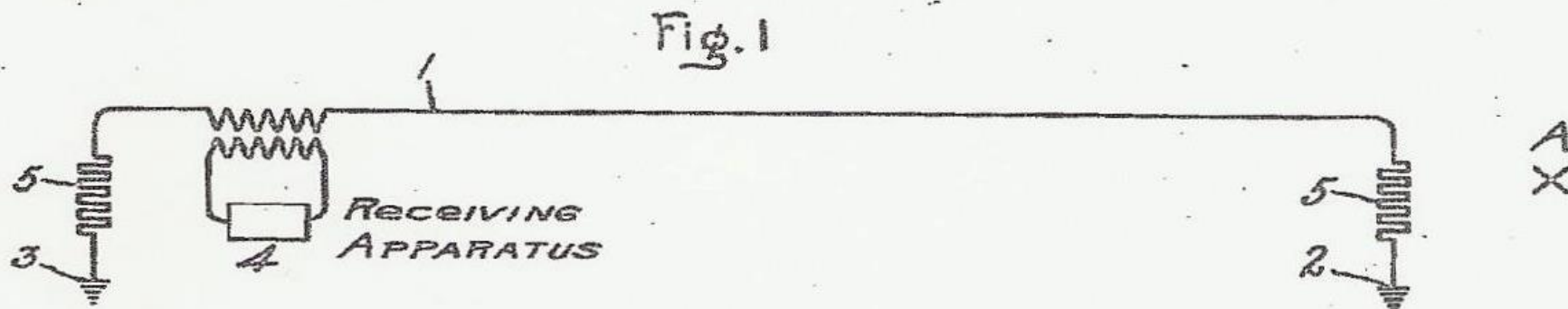

Inventor:
Harold H. Beverage,
by *Arthur G. Davis*
His Attorney.

Single Wire Beverage

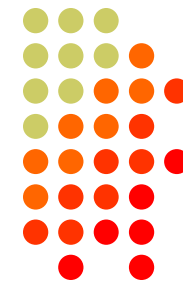

The simplest and most reliable high performance receiving antenna

250 to 400 feet long	100°-120° 3 dB beam width	7-10 dB RDF
500 to 750 feet long	70-80° 3 dB beam width	10-12 dB RDF
750 to 1000 feet long	60° 3 dB beam width	12-13 dB RDF

Beverage Simulations - 3 feet high, avg gnd,
1.85 MHz, #18 copper wire, teflon ins 8 mils thick
(data at best F/B plotted)

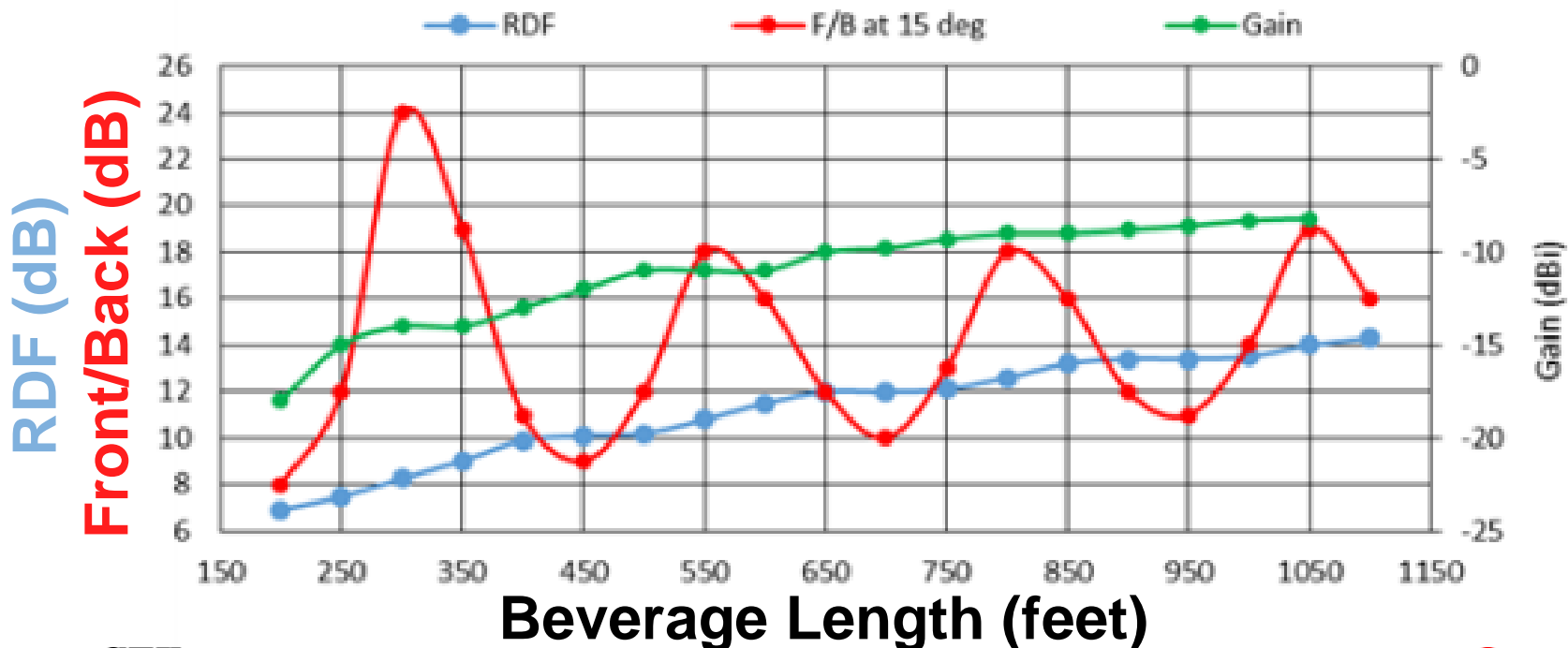

o CTU o

CONTEST UNIVERSITY

[k9la.us/Trends in Beverage and BOG Performance.pdf](http://k9la.us/Trends%20in%20Beverage%20and%20BOG%20Performance.pdf)

ICOM

Beverage on (very near) Ground

6 dB RDF with only 225 feet of length

a good choice when stealth is important

signal levels are *much stronger* if the wire is elevated just a few inches
only about 225 feet long -- *longer lengths significantly degrade performance*

90 to 100° 3 dB beam width

Very low signal levels – requires a high gain preamp with very low noise figure



Two Wire Bi-directional Beverage - 1921

Switchable in two directions with one feed line

deep steerable rear null if both feed lines feed a variable phase controller

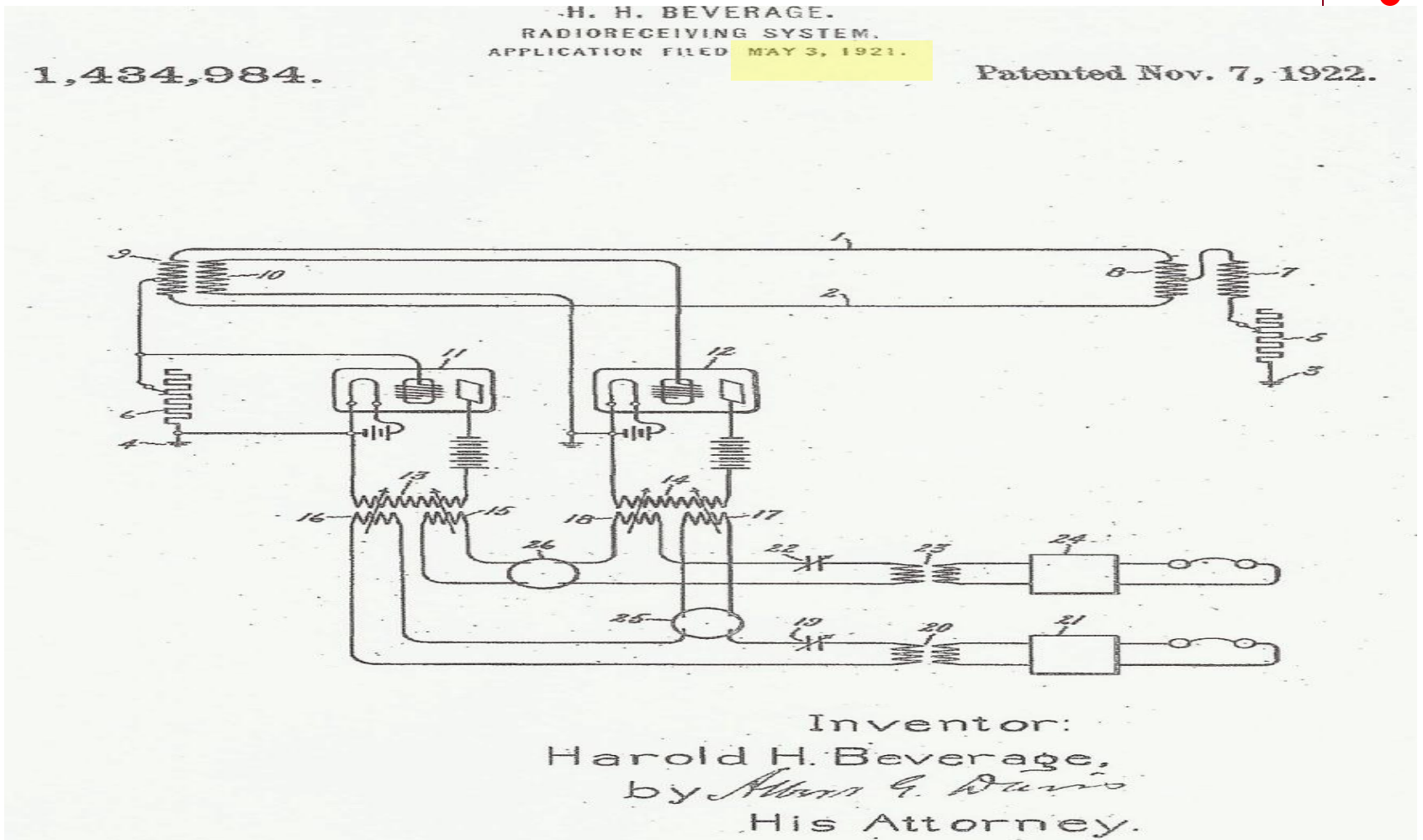

Radiation Pattern of a 600 Foot Beverage

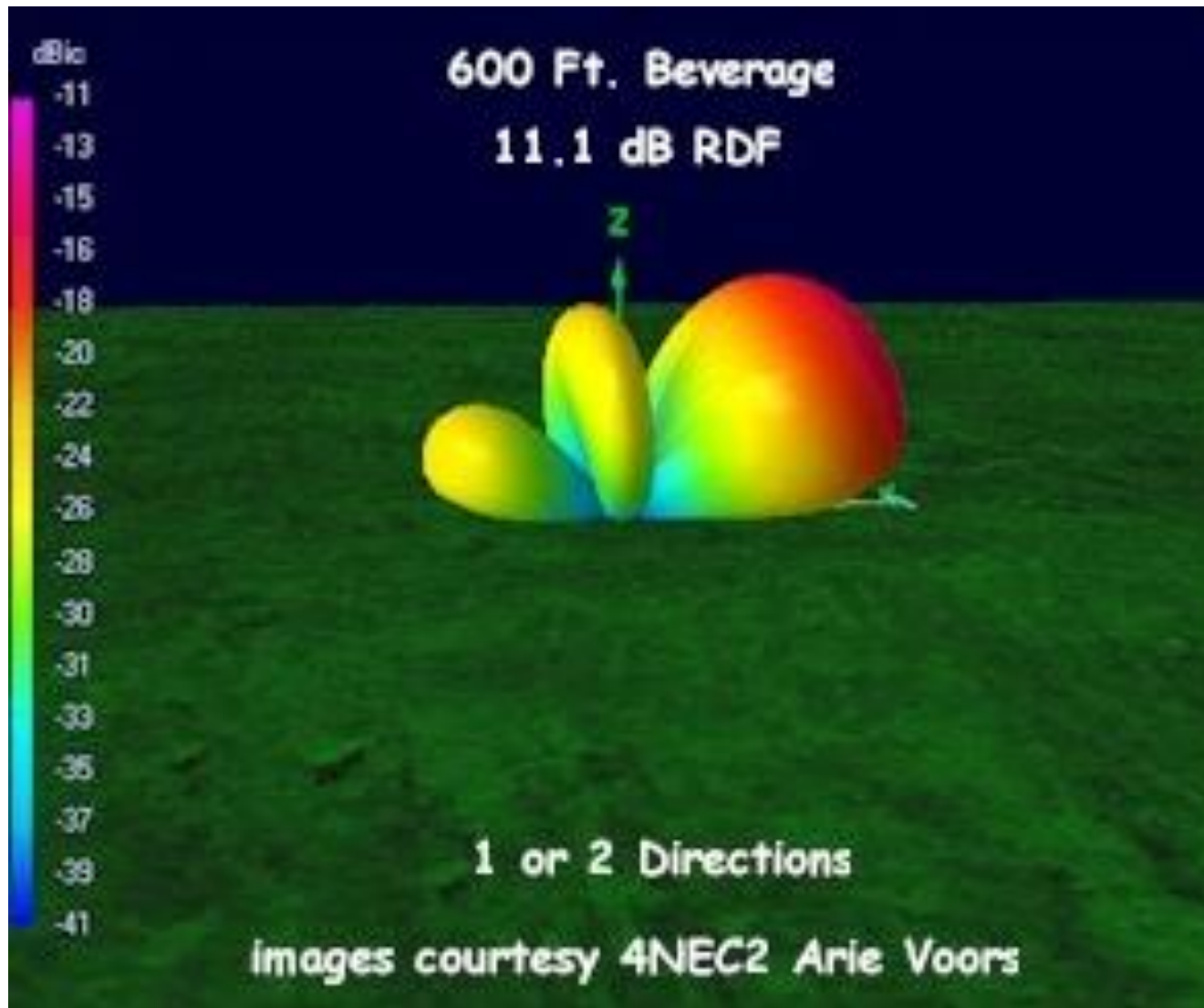

Staggered Beverage Array - 1927

11 dB RDF on one acre

Two or three close spaced, 500 to 600 foot staggered Beverages
or two or three close spaced 225 foot BOGs – **but only 7 dB RDF**

Enhanced front-to-back ratio compared to a single Beverage or BOG

The deep rear null can be steered by a variable phase controller



Sept. 1, 1931.

H. O. PETERSON

1,821,402

ANTENNA

Filed Nov. 8, 1927

2 Sheets-Sheet 2

Fig. 7

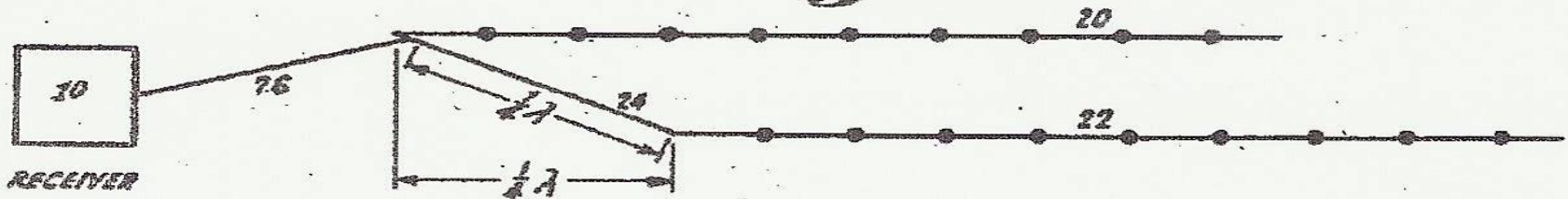

Broadside Pair of Staggered Beverages - 1927

14 dB RDF on 8 Acres

800 foot Beverages, 350 foot broad side spacing

50° 3 dB beam width



Sept. 1, 1931.

H. O. PETERSON

1,821,402

ANTENNA

Filed Nov. 8, 1927

2 Sheets-Sheet 2

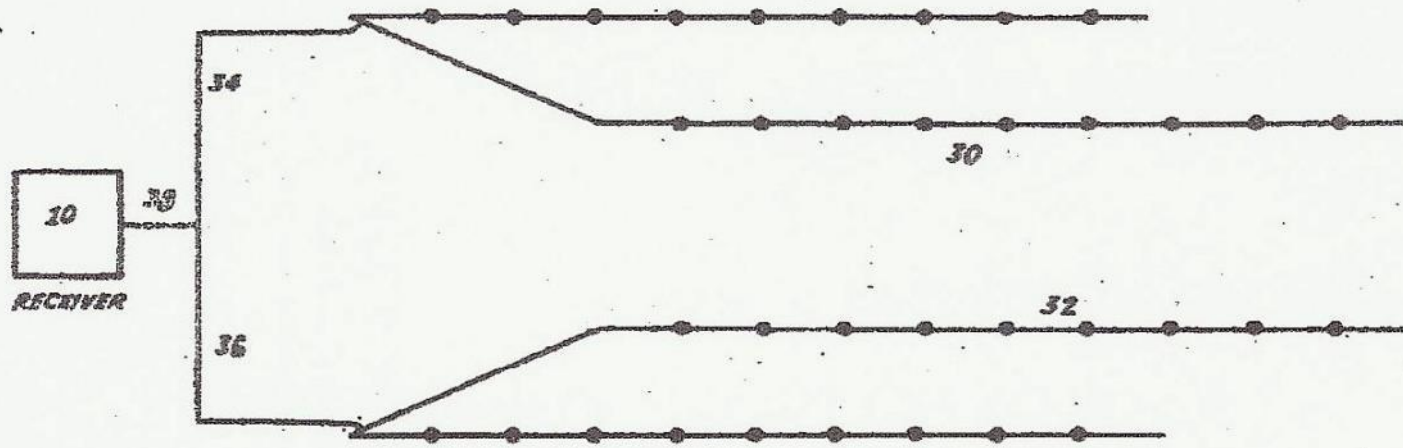

Phased High Impedance Verticals

Two or More 20 Foot Verticals



No radials

No umbrella wires

Switchable in multiple directions

Multi-band operation with compromise 65 foot element spacing

80 foot element spacing for improved 160 meter performance

- somewhat closer spacing is possible by using a variable phase controller

High input impedance amplifier at the feed point of each vertical

- **stray capacitance must be reduced to a very low amount**
in the construction of the feed point of each vertical and amplifier input

Verticals must not be installed within ten feet of nearby objects

- Avoid nearby trees or any conductive or partially conductive structure

Avoid re-radiated signals from nearby antennas and power lines

- locate the antenna as far as possible from antennas, towers and power lines

Radiation Pattern of a Two Element Array of 20 Foot Verticals

9 dB RDF in 80 feet or less

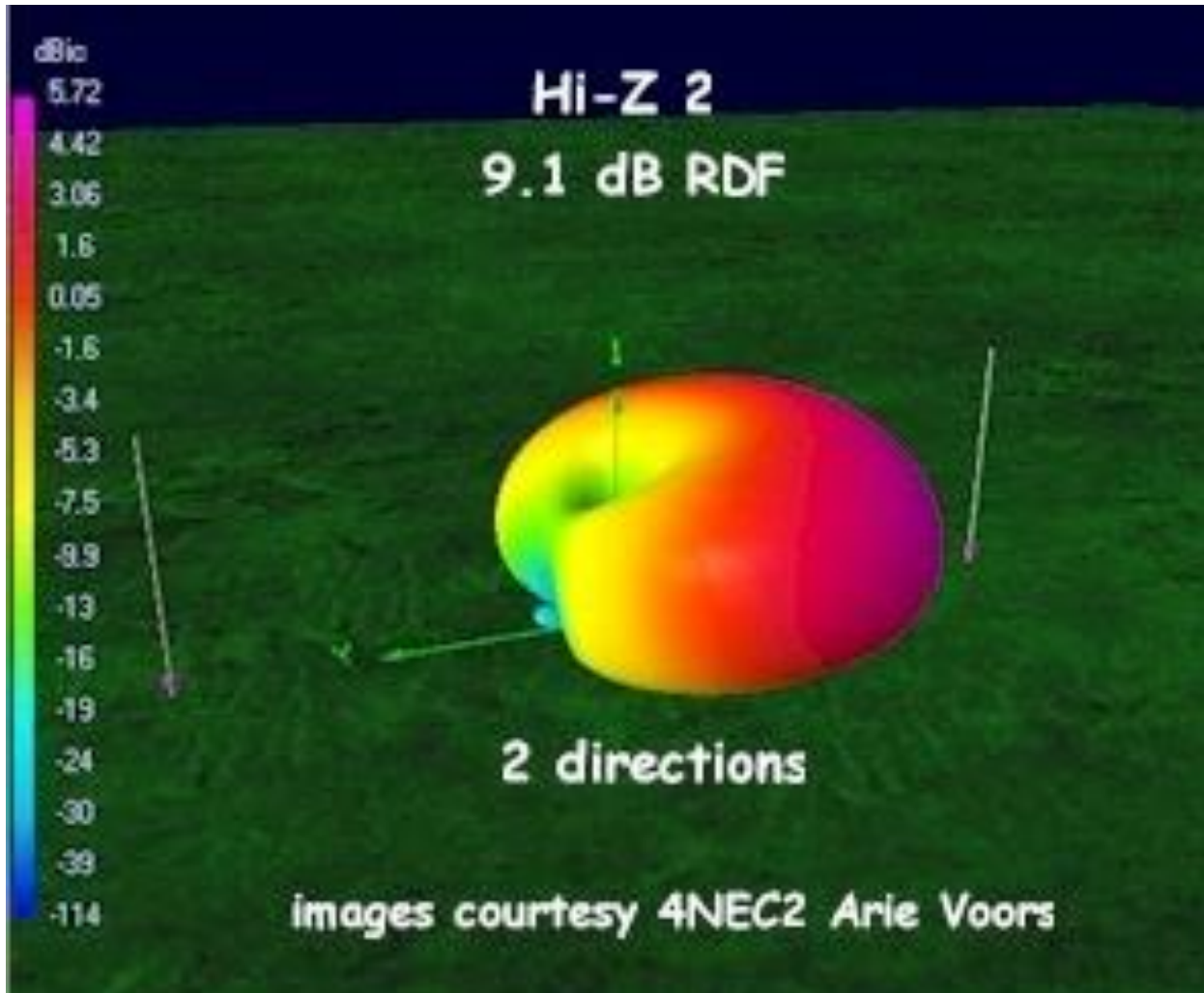

Electrically Steerable 4-Square Vertical Array

12 dB RDF on less than 1/4 acre

four *high impedance* 20 foot verticals

no radials no umbrella wires

80 x 80 foot square x 20 feet high

high input impedance amplifier at the base of each vertical

switchable in four or eight directions

100° 3 dB beam width



OZ1RDP
Photo

Radiation Pattern of a 4-Square Array of 20 Foot Verticals 12 dB RDF on less than ¼ acre

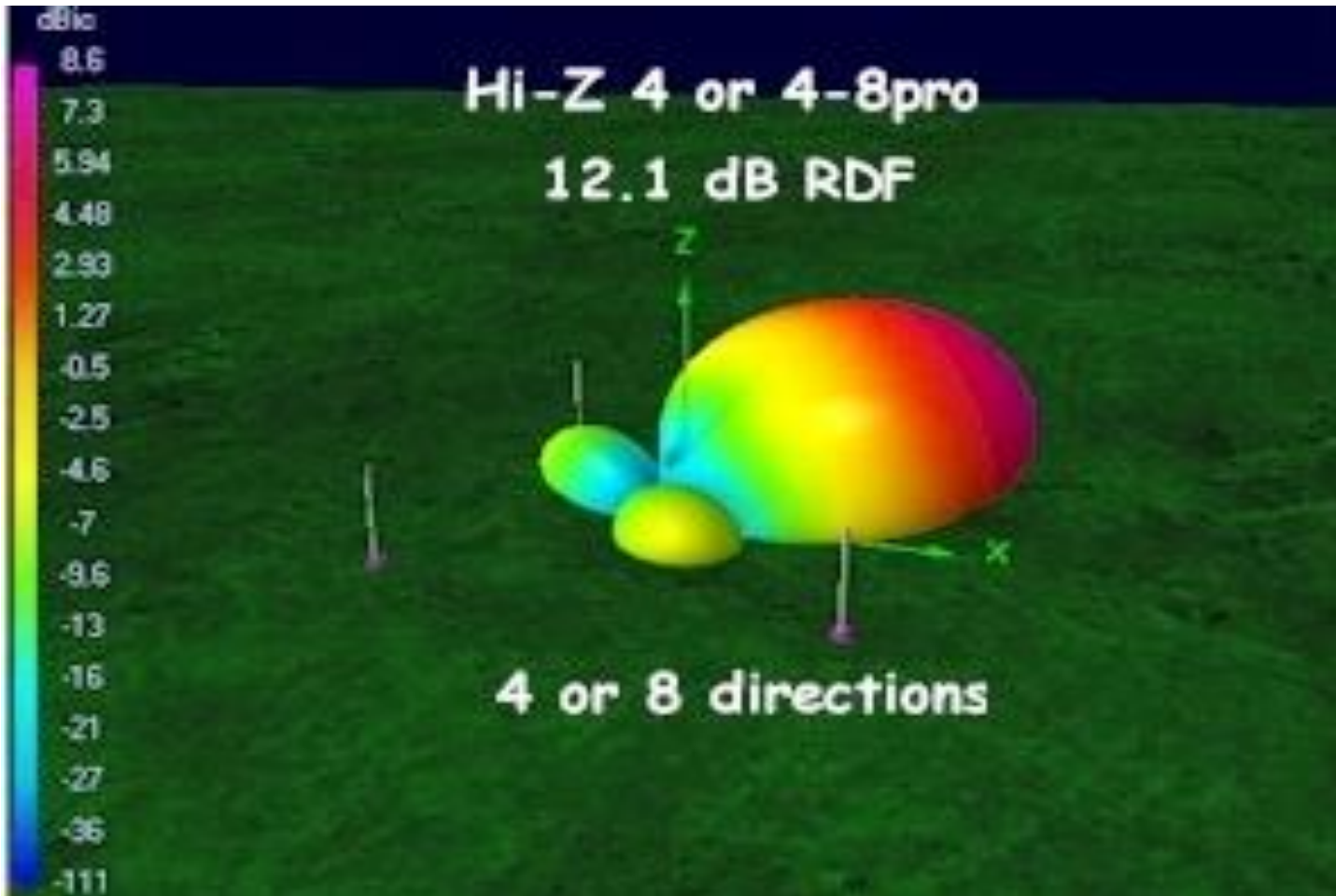

Electrically Steerable 8-Circle Vertical Array

13.5 dB RDF on only $\frac{3}{4}$ acre

eight *high impedance* 20 foot verticals

no radials and no umbrella wires

requires a high input impedance amplifier at the base of each vertical

only 200 feet in diameter

switchable in eight directions with 106° phasing

50° 3 dB beam width, equivalent to a 5 element Yagi



◦ CTU ◦

CONTEST
UNIVERSITY

hizantennas.com/8_element_arrays.htm

ICOM[®]

200 Foot Diameter 8-Circle Array Radiation Pattern

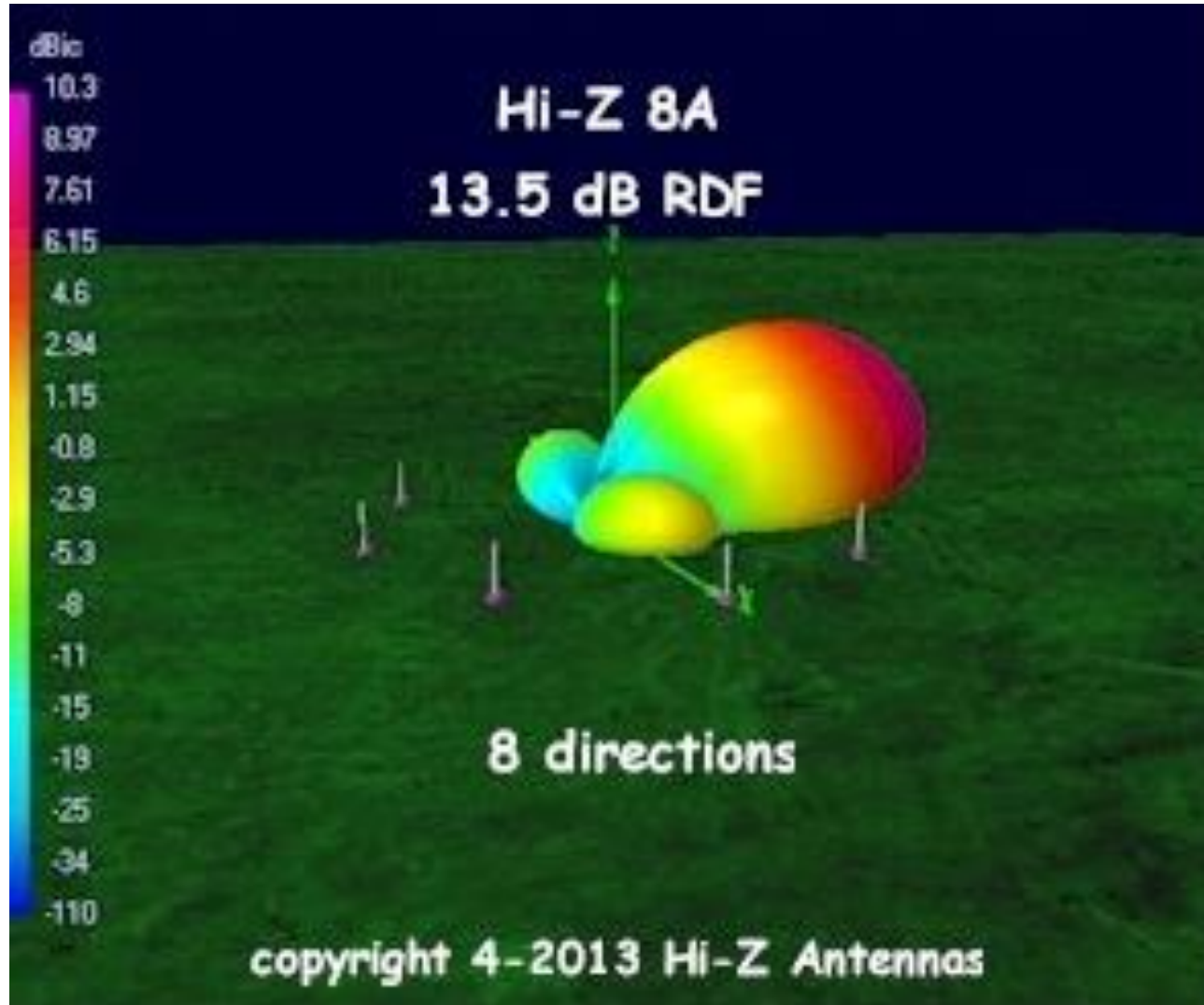

YCCC Triband Receiving Array

12 dB RDF on only ¼ acre



3, 5 and 9 element configurations with identical performance

- switchable in 180°, 90° and 45° azimuth steps respectively
- 80° 3 dB beam width
- slightly wider beam width and slightly lower RDF on 80 and 40 meters

120 feet in diameter

No radials

No umbrella wires

High impedance amplifier at the feed point of each 20 foot vertical

A common mode choke must be attached to each feedline where it connects to the controller

Install at least 10 feet from nearby trees and metallic structures

Avoid re-radiation from nearby towers, antennas and power lines

- locate the antenna as far as possible from other antennas and power lines

Phased *Low Impedance* Verticals

Two or More 25 Foot Monoband Umbrella Verticals



Short radials are required at the base of each vertical

- eight 70 foot radials, sixteen 35 foot radials or chicken wire
- randomly laid on the ground or shallow buried, symmetry is not important

Four 25 foot umbrella wires attached to the top of each vertical

- umbrella wires reduce antenna height and improve array bandwidth
- or use 35 foot verticals with no umbrella wires

As little as 65 foot element spacing

- small spacing works best when used with a variable phase controller

Amplifiers not needed at the base of each vertical - better reliability

Switchable in multiple directions

Very easy and low cost to homebrew your own antenna

- large diameter arrays are very tolerant of moderate amplitude and phase errors

Low impedance verticals are tolerant of nearby trees and buildings

Avoid re-radiated signals from nearby towers, antennas and power lines

- locate the antenna as far as possible from other antennas and power lines

Electrically Steerable 4-Square Vertical Array



12 dB RDF on 1/4 acre

four *low impedance* 25 foot umbrella verticals

four 25 foot umbrella wires attached to the top of each vertical

eight 70 foot radials or sixteen 35 foot radials per vertical

65 x 65 foot square footprint plus additional space for short radials

switchable in four directions

easy and inexpensive to build

100° 3 dB beam width



OZ1RDP
photo

◦ CTU ◦

CONTEST
UNIVERSITY

www.iv3prk.it/user/image/site2-rxant.prk_4-square_1.pdf

ICOM®

Electrically Steerable 8-Circle Vertical Array

13.5 dB RDF on four acres

eight *low impedance* 25 foot umbrella verticals

four 25 foot umbrella wires installed on each vertical

eight 70 foot radials or sixteen 35 foot radials installed under each vertical

350 foot diameter plus space for radials

or only 200 foot diameter when used with a Hi-Z 106° phasing controller
switchable in eight directions

Very easy and inexpensive to build

50° 3 dB beam width, equivalent to a 5 element Yagi

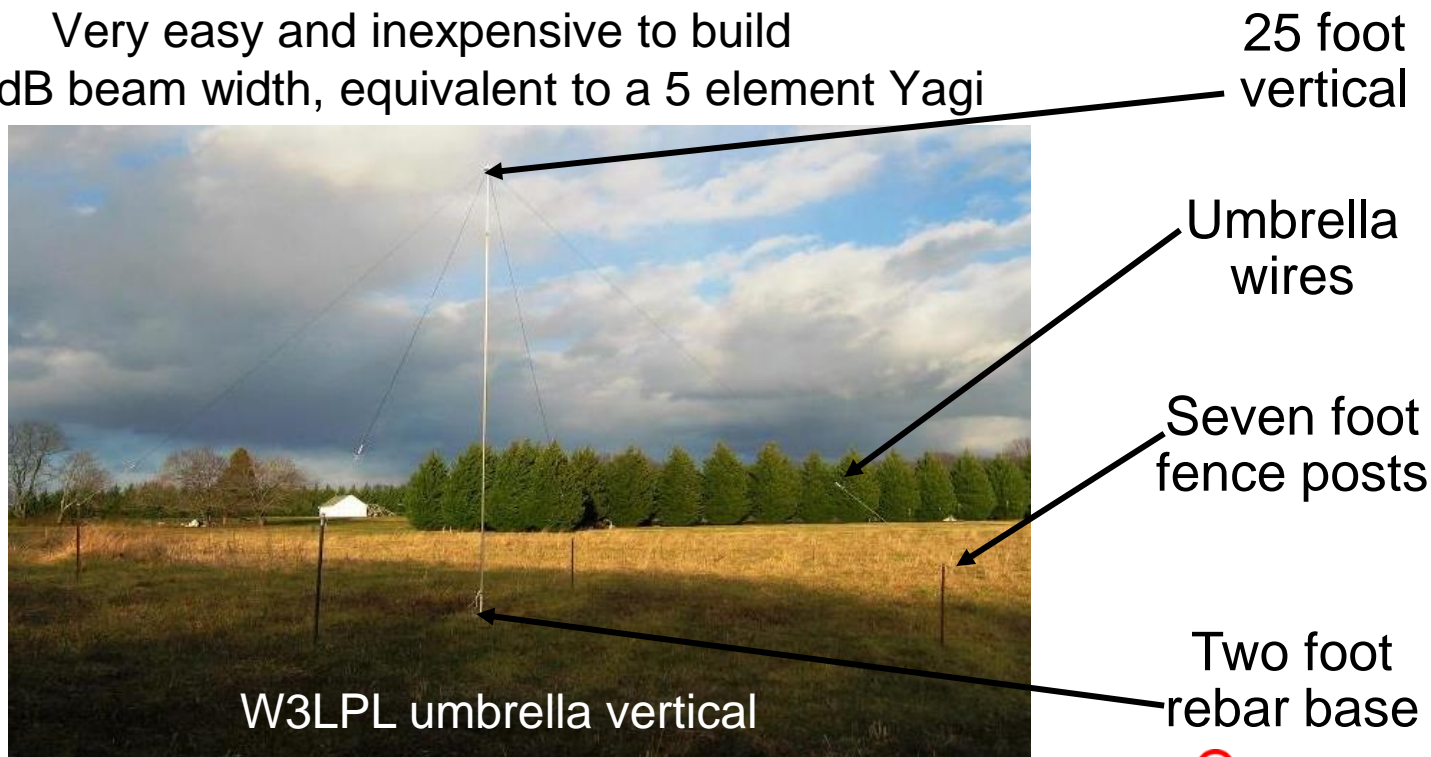

construction details: www.w5zn.org

350 Foot Diameter 8-Circle Array Radiation Pattern

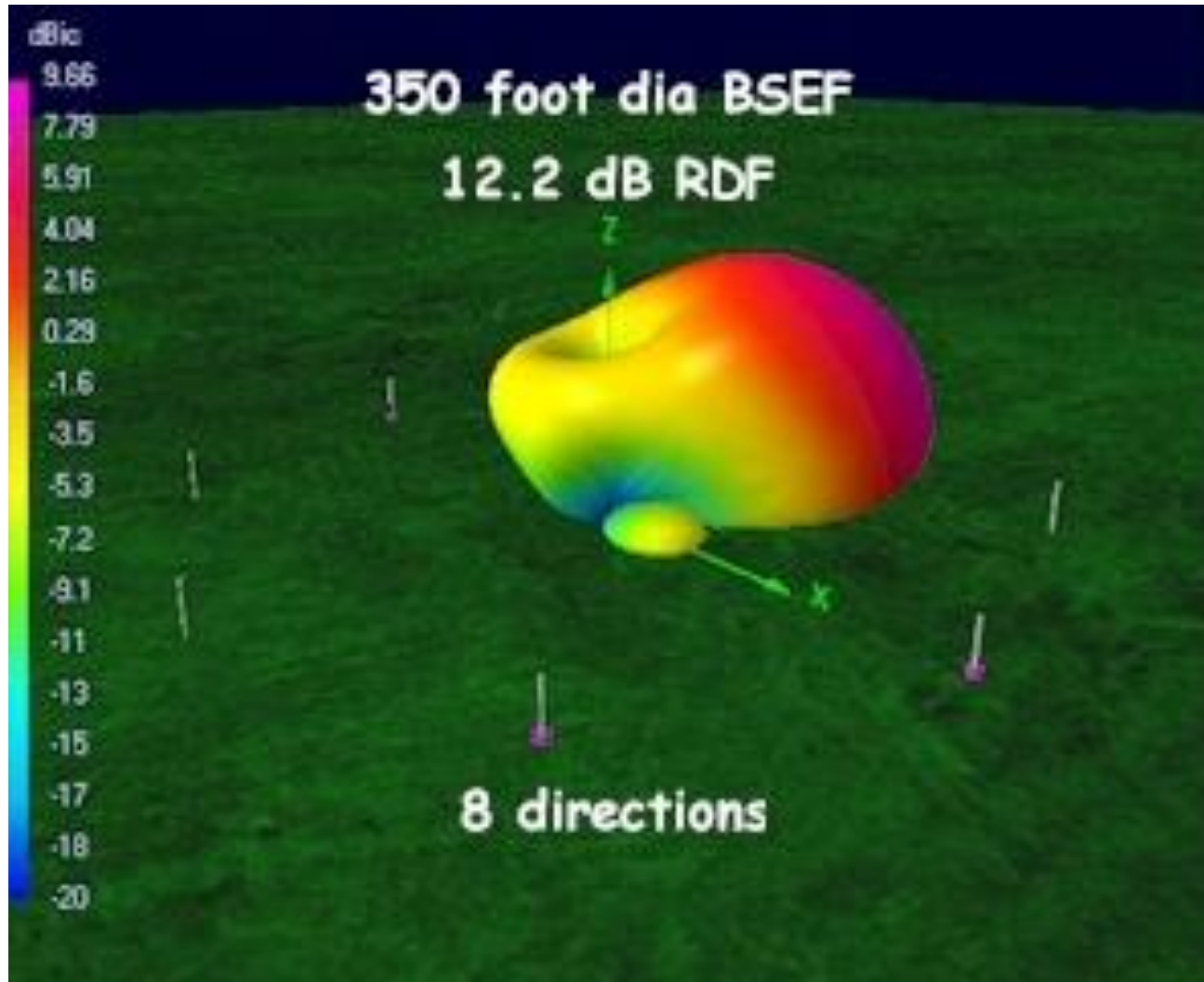

160 and 80 Meter Receiving Antenna Layout at W3LPL

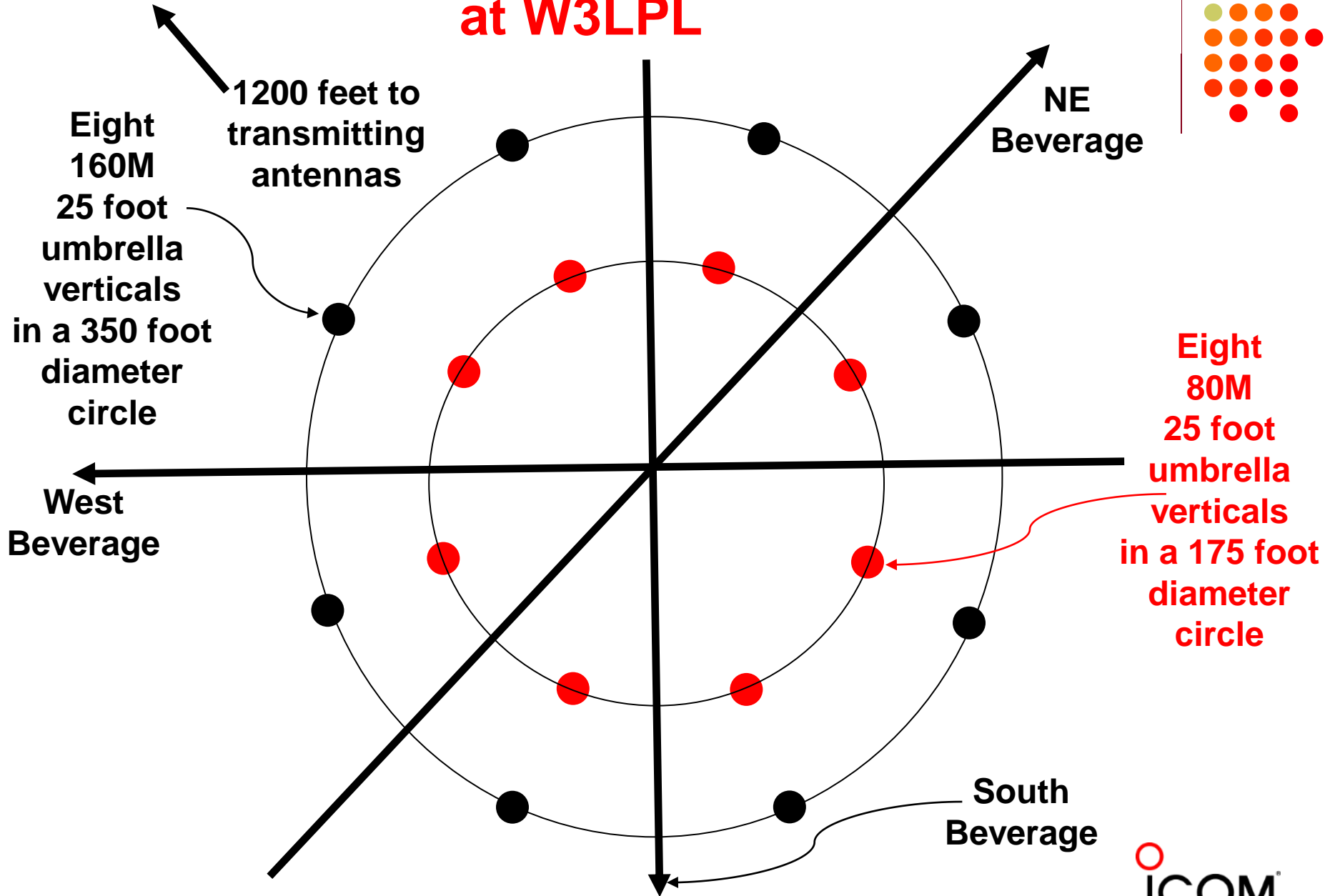

Receiving Antenna Phasing System

DX Engineering NCC-2



Combines the inputs from two antennas

- creates a directional pattern with steerable deep nulls
- significantly improves the performance of phased Beverages and phased verticals
- very well engineered and exceptionally easy to use



Phase Synchronous Diversity Reception

Two widely spaced antennas (at least 500 foot spacing)
feed two identical high performance phase locked receivers

